

Understanding Digital AV Principles, Technology and Connectivity - A Comprehensive Overview

*Joseph D. Cornwall
CTS-D, CTS-I, LEED GA, ISF-C, FOI
Technology Evangelist, Legrand NA*



2017 BICSI Winter Conference & Exhibition

January 22-26 • Tampa, FL

Technology's Place In Learning

- *“An education isn't how much you have committed to memory, or even how much you know. It's being able to differentiate between what you do know and what you don't.” - Jacques Anatole Francois Thibault*



2017

BICSI Winter Conference & Exhibition

January 22-26 • Tampa, FL

Our Agenda

*Where Are We
Today?*

*The Digital Video
Payload*

*Display Size and
Resolution*

*Applying ANSI-
InfoComm 5M-
2012 DISCAS*

Break

*Review of
Wireless AV
Connectivity*

*New Trends In
Copper & Fiber
Connectivity*

*Summary
Q&A*



2017

BICSI Winter Conference & Exhibition

January 22-26 • Tampa, FL

The State of AV Communications

“There is an evil tendency underlying all our technology - the tendency to do what is reasonable even when it isn't any good.” - Robert Pirsig



2017

BICSI Winter Conference & Exhibition

January 22-26 • Tampa, FL

Network Connectivity

- How Big Is A Gigabyte, Really?
 - Novel = 1 MB
 - Pickup truck full of books = 1 GB
 - 2 hour Blu-Ray movie = 358GB
- Today...
 - 216,000 Instagram
 - 204,000,000 Emails
 - 12 hours of YouTube
 - 277,000 Tweets

Are uploaded *every minute!*



2017

BICSI Winter Conference & Exhibition

January 22-26 • Tampa, FL

How Much Is Enough?

- 1992 - 100 GB per *day*
 - 1997 - 100 GB per *hour*
 - 2002 - 100 GB per *second*
 - 2007 - 2,000 GB per second
 - 2014 - 16,144 GB per second
 - 2019 - 51,794 GB per second
- IoT = 50 billion devices by 2020

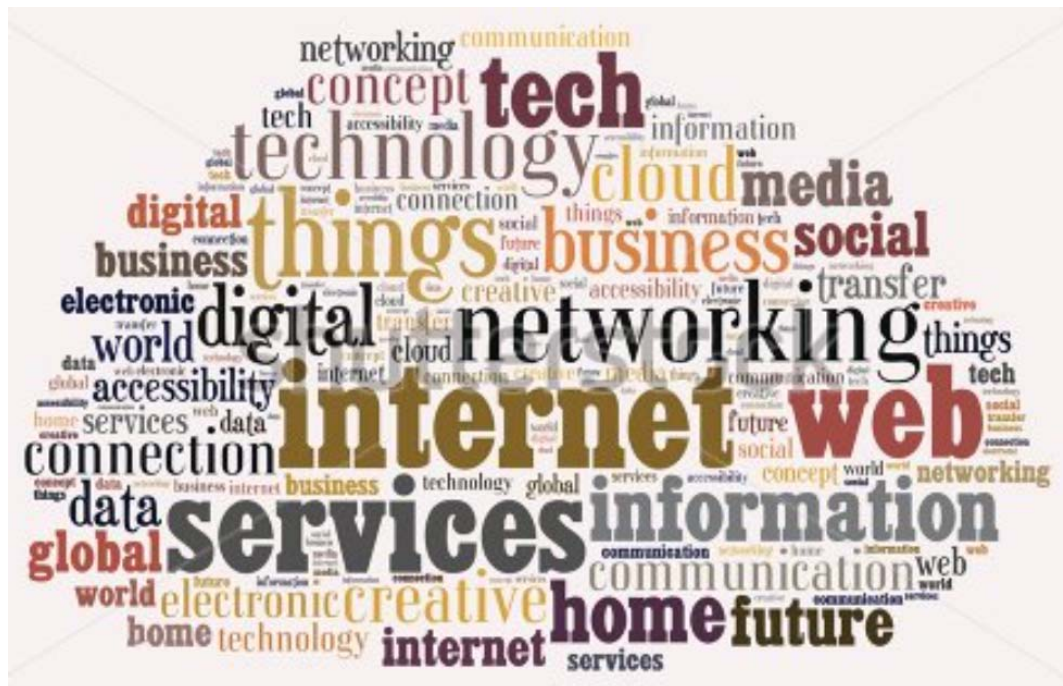

2017

BICSI Winter Conference & Exhibition

January 22-26 • Tampa, FL

Where the 'Internet of Thing' Gets the "S"

The "Basket of Remotes" problem

- Most devices can't advertise their status and operation
- Only when devices advertise control and reporting data can inclusive apps be developed

IoT will facilitate a data stream between devices and a decentralized management system

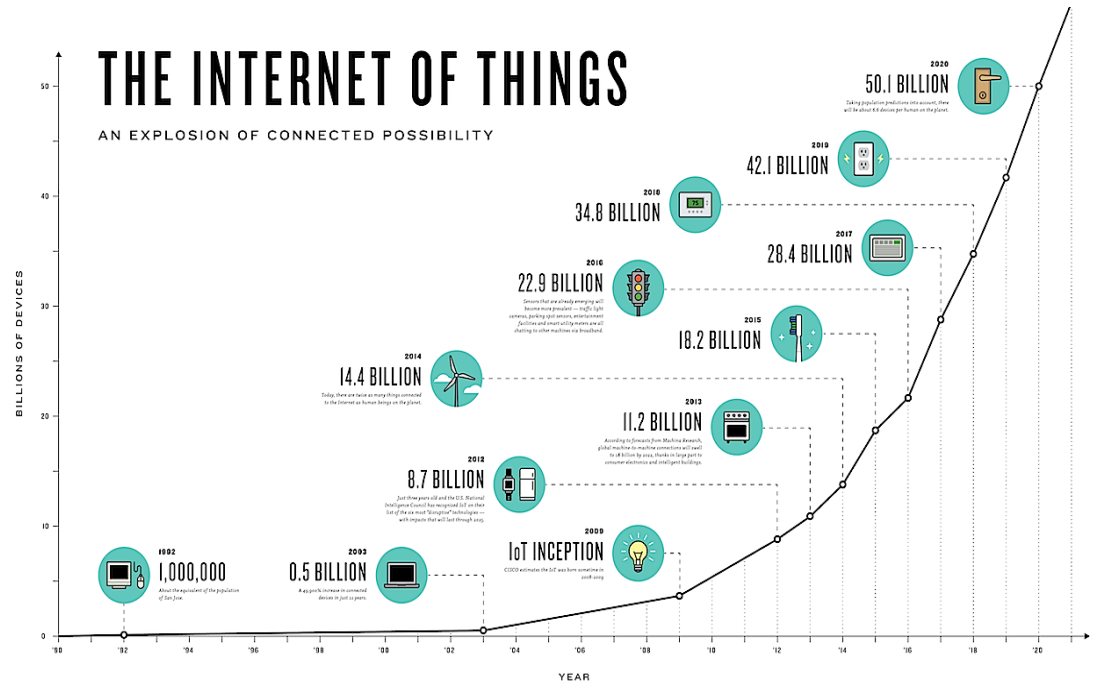

2017

BICSI Winter Conference & Exhibition

January 22-26 • Tampa, FL



Digital Natives

- Intuitive integration of mobile and stationary assets
- Unfettered integration of work and personal technology
- Sensible integration of cloud, premise and local storage
- Uninterrupted access that blurs the lines between content and carrier



2017

BICSI Winter Conference & Exhibition

January 22-26 • Tampa, FL

Design Forward...

- Device to Device



- Device to Human



- Human to Device



- Human to Human



2017

BICSI Winter Conference & Exhibition

January 22-26 • Tampa, FL

Huddle Space Best Practices

- Multiple “stations” that provide wired connectivity to a shared screen, power, control
 - Flexible arrangement, configurable assets, ubiquitous form factors
 - Well considered **wired** infrastructure is the foundation for effective community connectivity



2017

BICSI Winter Conference & Exhibition

January 22-26 • Tampa, FL

Growth Of Interactive Interface Solutions

- Interactive displays are dynamic information image devices which can be operated through touch
- Interactive display market is forecast to grow at more than 17% CAGR through 2017
- Factors driving the growth of the market include widespread deployment of digital learning, digital textbooks



2017

BICSI Winter Conference & Exhibition

January 22-26 • Tampa, FL

Technology's Value \propto Utility



Individual Workspaces

Huddle Spaces

Conference Rooms

Classrooms and Training Rooms



2017

BICSI Winter Conference & Exhibition

January 22-26 • Tampa, FL

What is The Digital Video Payload?

“For a successful technology, reality must take precedence over public relations, for Nature cannot be fooled.” - Richard Feynman



2017

BICSI Winter Conference & Exhibition

January 22-26 • Tampa, FL

The Elements of a Video Signal

- Bandwidth \propto visual detail
 - In analog systems, the ability to pass higher frequencies equates to the ability to display finer detail
- Amplitude \propto color saturation
- RGB additive color model divides a video signal into 3 "components"
 - **R**GB or **Y**C**b**C**r** (YPbPr)
- Chroma decimation

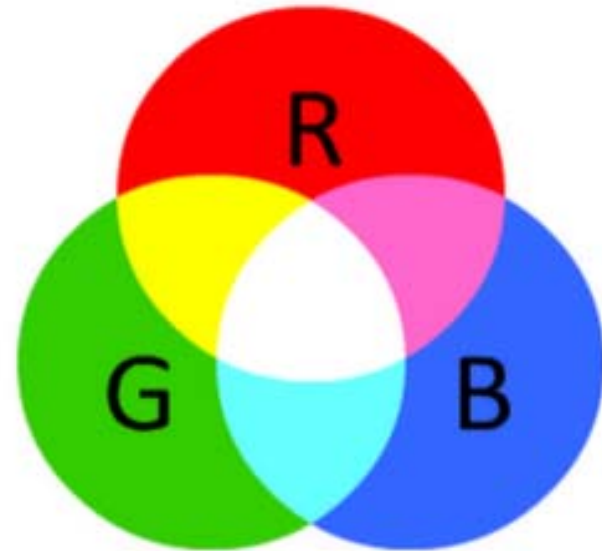

2017

BICSI Winter Conference & Exhibition

January 22-26 • Tampa, FL

Chroma Subsampling

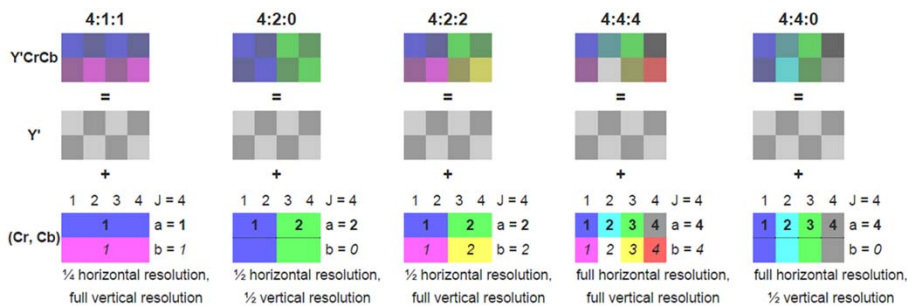

- 4:4:4 **RGB** “deep color”
- Typically 8-bits per component
- Up to 16-bits per component
- 4:2:0 **YCbCr**

4:4:4 Each R, G, and B channel is sampled at the same rate. Maximum color detail is maintained.

4:2:2 The color channels are subsampled so that the color resolution is halved. For example, the first pixel in a line contains Y', CB, and CR samples. The next pixel contains only a Y' sample. This pattern repeats. Most professional video formats use 4:2:2 color subsampling.

4:2:0 This ratio indicates that the CB and CR channels are subsampled both horizontally (as in 4:2:2) and vertically. This reduces color resolution.



2017

BICSI Winter Conference & Exhibition

January 22-26 • Tampa, FL

Digital Audio

- Digital audio is not a discrete element of the DV payload
 - Bits are “fungible”
 - Digital audio is embedded into the horizontal ancillary data space (HANC) of the
 - Audio travels with video

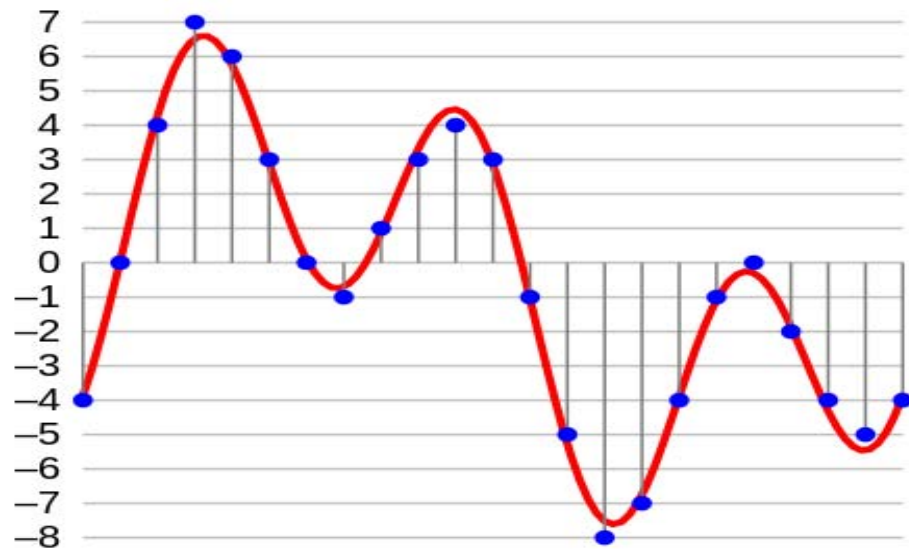

A sound wave, in red, represented digitally, in blue (after sampling and 4-bit quantization).



2017

BICSI Winter Conference & Exhibition

January 22-26 • Tampa, FL

Digital Rights Protection - HDCP

- High Bandwidth Digital Content Protection (HDCP) is a technology designed to allow digital rights management implementation of AV content
- **Converting digital video w/ HDCP is forbidden unless the output supports the HDCP protection**

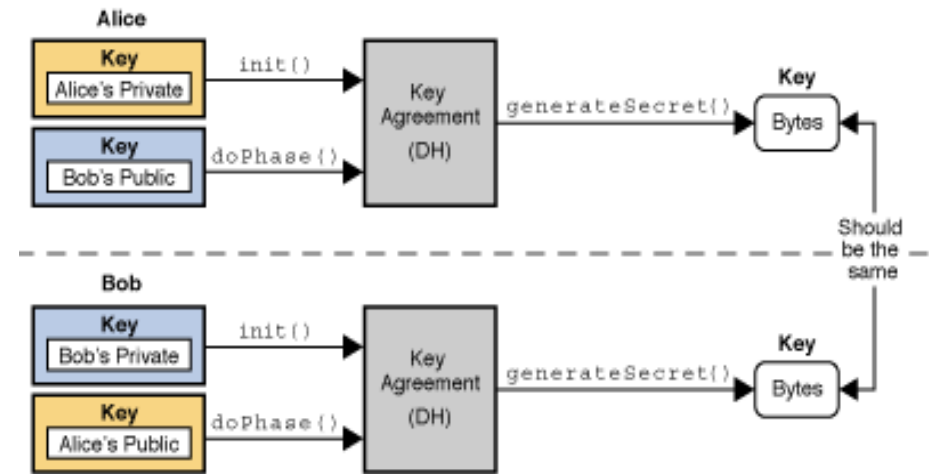
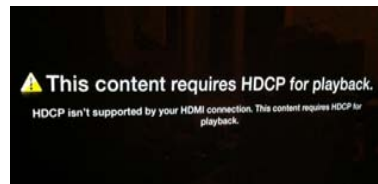

2017

BICSI Winter Conference & Exhibition

January 22-26 • Tampa, FL

- HDCP 2.2 is designed to create a secure 4K content connection
 - Encryption on HDCP2.2 keys is more advanced
 - Includes “locality check” which requires $\leq 20\text{mS}$ latency source-to-sink
- HDCP 2.2 is not a firmware upgrade. This technology demands full hardware compatibility
 - All components in a system must support HDCP 2.2, including switchers, D/A, audio devices, etc....

UltraHD

HDMI 2.0 / HDCP 2.2 SUPPORT



2017

BICSI Winter Conference & Exhibition

January 22-26 • Tampa, FL

System Control

- RS232
- CEC is an HDMI feature designed to allow the user to control enabled devices
 - Allows for individual CEC-enabled devices to command and control each other without user intervention
- Infra Red
- USB
 - If “Interactive” is involved, so is USB!

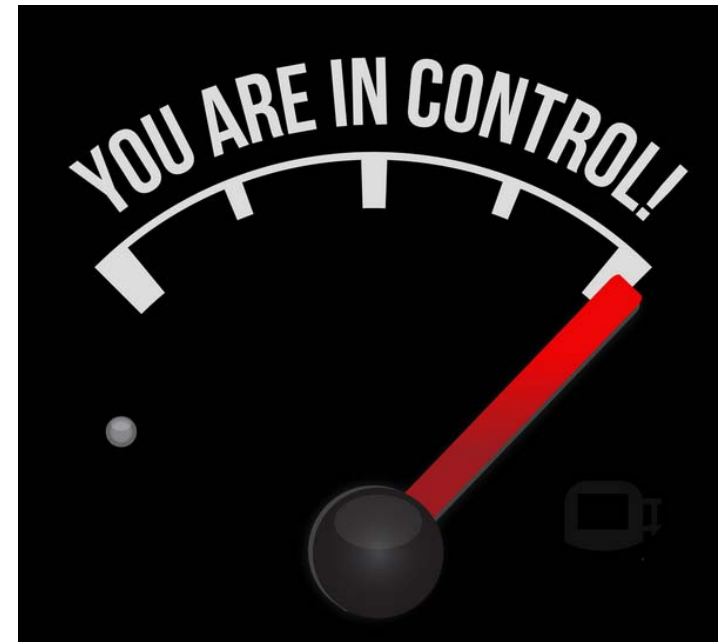

2017

BICSI Winter Conference & Exhibition

January 22-26 • Tampa, FL

DDC, EDID and DisplayID

- Display Data Channel
- Extended Display Identification Data (EDID)
- Enables the display (sink) to communicate supported display modes to the source via a compact binary file format that describes the monitor's capabilities and supported graphics modes
- Stored in a read-only memory chip programmed by the manufacturer of the monitor

EDID Development History	
EDID	Defines the data structures sent from a video display to a source over E-DDC lines to describe its capabilities
EDID 1.0	Defined original 128-byte data structure (Deprecated)
EDID 1.1	Defined some alternative uses for space in data structure (Deprecated)
EDID 1.2	Defined some alternative uses for space in data structure (Deprecated)
EDID 1.3	Current definitions for 128-byte EDID data fields
EDID 2.0	Introduced new 256-byte data structure
E-EDID	Defined optional additional 128-byte extension blocks for EDID 1.3, incorporated EDID 2.0 as optional extensions
DisplayID	Introduced variable length data structure



2017

BICSI Winter Conference & Exhibition

January 22-26 • Tampa, FL

UltraHD Is Bigger Than 8 Million Pixels



2017

BICSI Winter Conference & Exhibition

January 22-26 • Tampa, FL

Selecting The Right Display Size

“What we see depends mainly on what we look for.” - John Lubbock



2017

BICSI Winter Conference & Exhibition

January 22-26 • Tampa, FL

What Do We See?

- Electromagnetic energy reflects from a object
 - Only a small portion of the spectrum is visible
- Light enters through the cornea, is regulated by the iris, focused by the lens onto the retina
 - The retina has “sensors” that convert light to electro-chemical signals
 - Transported to the brain by the optic nerve

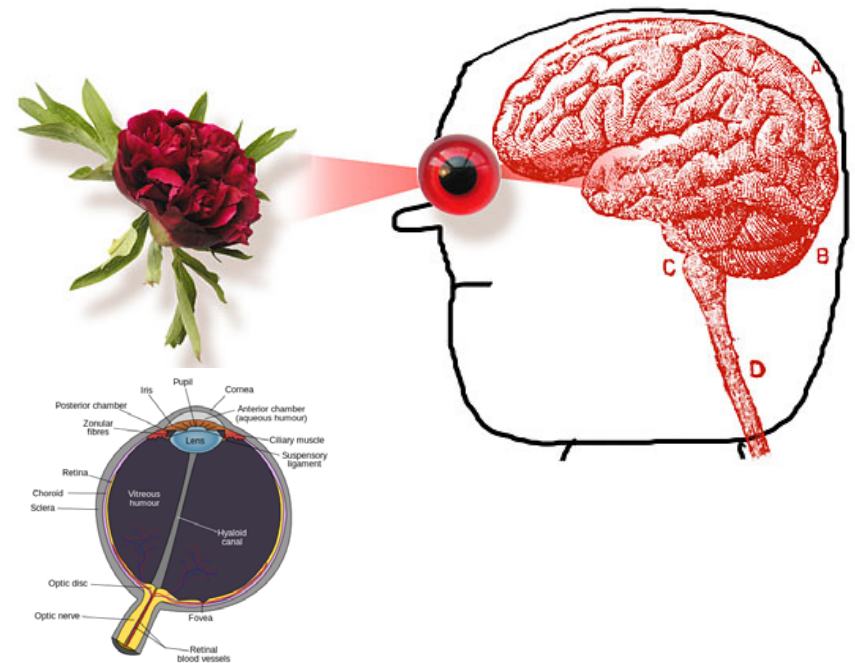

2017

BICSI Winter Conference & Exhibition

January 22-26 • Tampa, FL

Sight lines and Distances

- Reference 90-degrees perpendicular to the center of the screen
- Closest viewer should be no more than 1x screen *width* away
 - ✓ 27" LCD monitor viewed from 2 feet
 - ✓ 110" projection image viewed from 8 feet
- Top of the screen no more than 30-degrees above line of sight

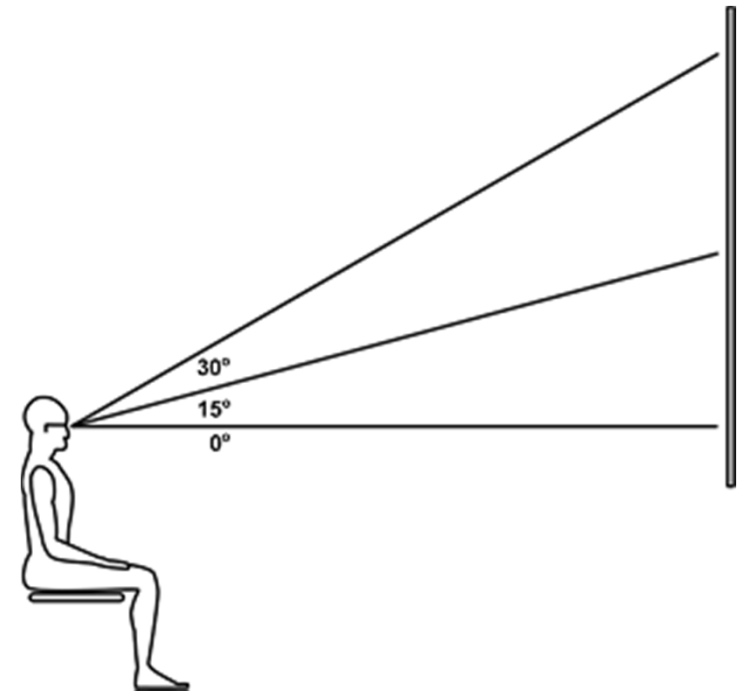

2017

BICSI Winter Conference & Exhibition

January 22-26 • Tampa, FL

The 4:6:8 Rule of Thumb

- 4x Image Height
 - ✓ Inspection of visuals "without clues" (maps, drawings, medical charts)
- 6x Image Height
 - ✓ Reading spreadsheets and websites
- 8x Image Height
 - ✓ For general video and "non-critical" viewing

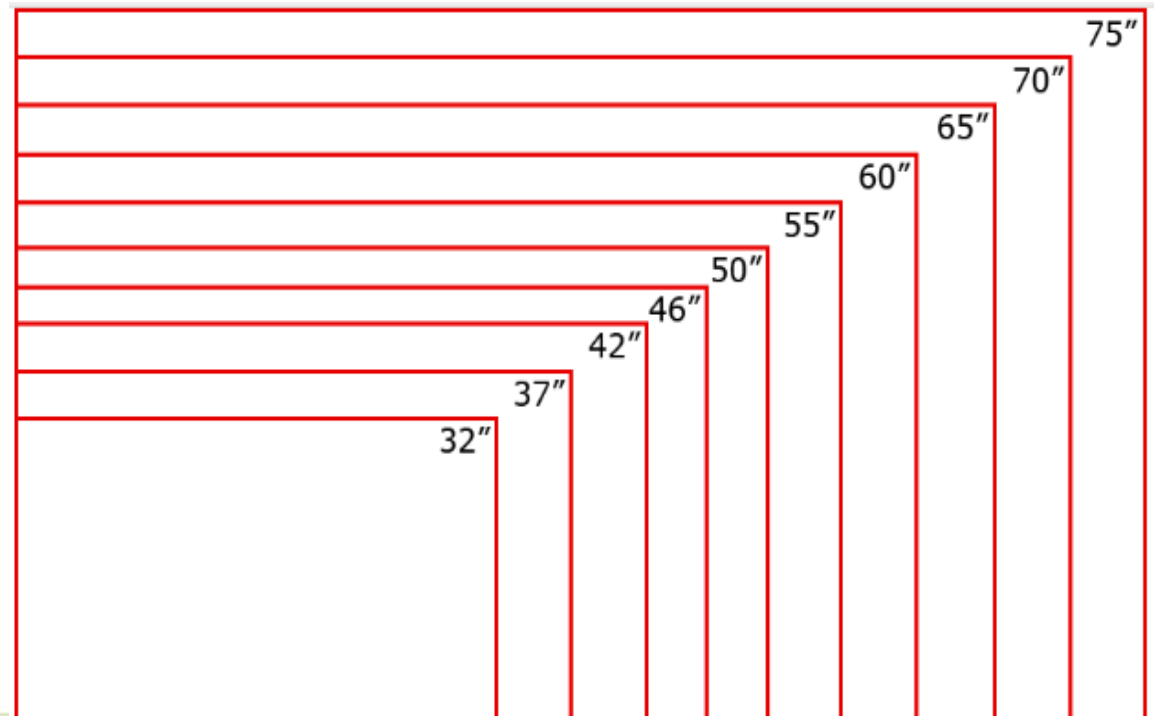

2017

BICSI Winter Conference & Exhibition

January 22-26 • Tampa, FL

The 150 Rule-of-Thumb For Text

- This is 14 point Calibri font
- This is 16 point Calibri font
- This is 18 point Calibri font
- This is 20 point Calibri font
- This is 24 point Calibri font
- This is 28 point Calibri font
- This is 32 point Calibri font
- This is 36 point Calibri font
- This is 36 point Arial font



2017

BICSI Winter Conference & Exhibition

January 22-26 • Tampa, FL

Display Image Size for 2D Content in Audiovisual Systems

- The goal of DISCAS is to create a scientific standard, based on human vision, to define the screen size for a given audiovisual system based on audience viewing distance.
 - ANSI/InfoComm 5M-2012



2017

BICSI Winter Conference & Exhibition

January 22-26 • Tampa, FL

Measuring The “Resolution” Of Your Eyes?

E	1	20/200
F P	2	20/100
T O Z	3	20/70
L P E D	4	20/50
P E C F D	5	20/40
E D F C Z P	6	20/30
FELOPZD	7	20/25
DEFPOTEC	8	20/20
LEFODPCT	9	
FDPLTCEO	10	
FEZOLCFYD	11	

	1	2	3	4	5
α	Black	Black	Black	Black	Black
b	White	Black	White	White	Black
c	White	Black	Black	White	White
d	White	White	White	Black	Black
e	Black	Black	Black	Black	Black



2017
BICSI Winter Conference & Exhibition
 January 22-26 • Tampa, FL

Visual Acuity

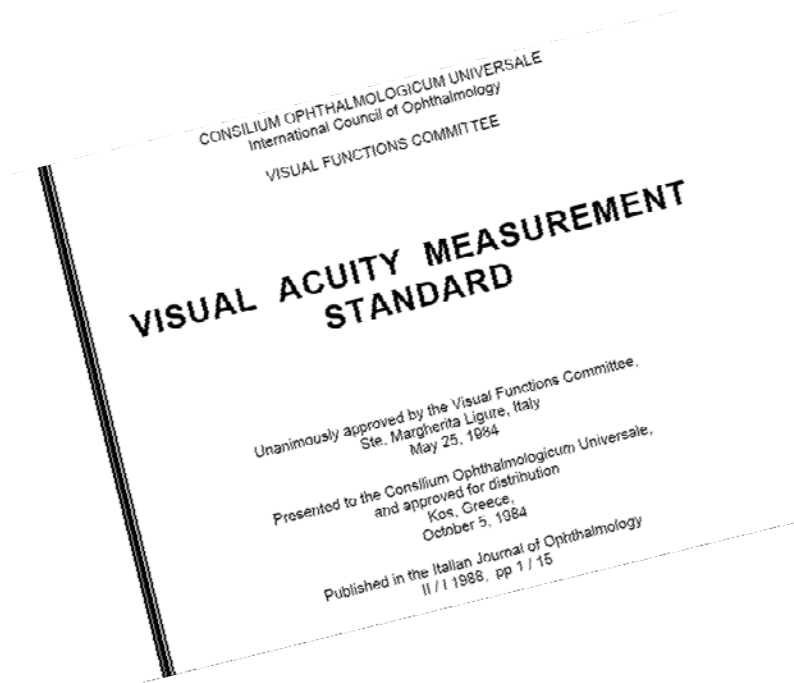

Visual acuity		Subtended MOA
20	12	0.6
20	14	0.7
20	16	0.8
20	18	0.9
20	20	1
20	22	1.1
20	24	1.2
20	26	1.3
20	28	1.4
20	30	1.5
20	32	1.6
20	34	1.7
20	36	1.8
20	38	1.9
20	40	2
20	42	2.1
20	44	2.2



2017

BICSI Winter Conference & Exhibition

January 22-26 • Tampa, FL

DISCAS Began With Analytic Viewing

- The ability to discern individual line pairs, which in today's technology, can be related to pixels.
 - Based on “Acuity of Vision” concepts
- Determining angles and sizes is explained by the Pythagorean Theorem in Euclidean geometry

$$a^2 + b^2 = c^2$$

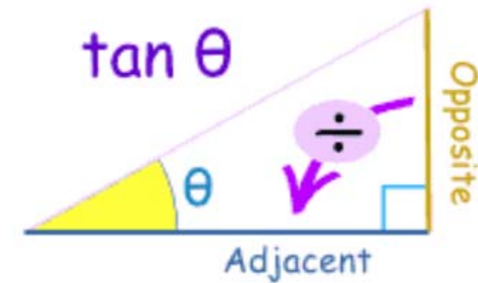
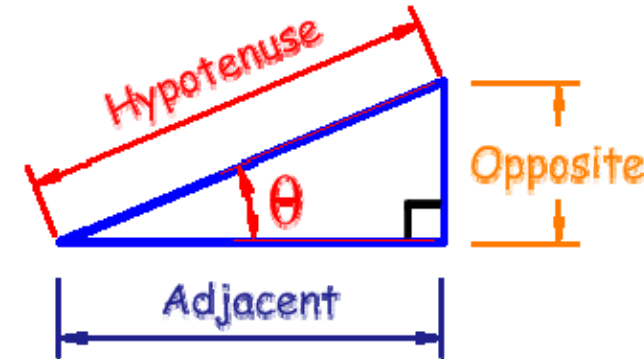

2017

BICSI Winter Conference & Exhibition

January 22-26 • Tampa, FL

The Formula

$$\text{Image Height} = (\text{Farthest Viewing Distance} * \# \text{ Vertical Pixels}) / (1 / \tan\left(\frac{\text{MOA}}{2}\right))$$

$$\text{Farthest Viewing Distance} = (\text{Image Height} * (1 / \tan\left(\frac{\text{MOA}}{2}\right))) / \# \text{ Vertical Pixels}$$



2017

BICSI Winter Conference & Exhibition

January 22-26 • Tampa, FL

VISUAL ACUITY FOR ANALYTICAL VIEWING

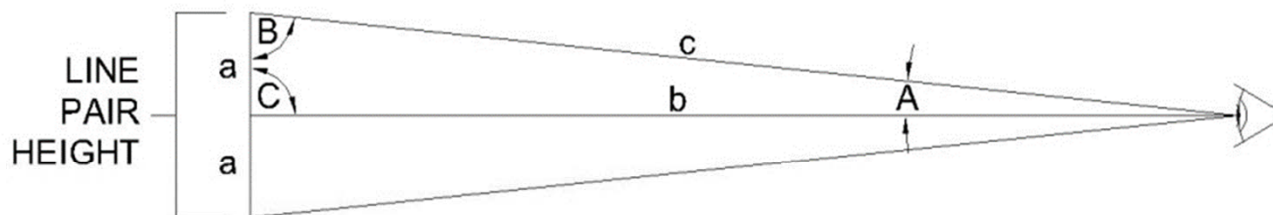

Pixel Height= a
 Line Pair Height= $2*a$
 Visual Acuity for Category= $2*A$
 Viewing Distance at Stated Acuity= b
 $\tan(A)=a/b$
 $b=a/\tan(A)$

ACUITY FACTOR FOR ANALYTICAL VIEWING

$$\frac{1}{\tan(\text{Visual Acuity}/2)} = 3438 \text{ for 2 Minutes of Arc}$$



2017

BICSI Winter Conference & Exhibition

January 22-26 • Tampa, FL

Simplifying the Math...

- ***Image Height*** =
$$\frac{\textit{Farthest Viewing Distance} * \# \textit{Vertical Pixels}}{3438}$$
- ***Farthest Viewing Distance*** =
$$\frac{\textit{Image Height} * 3438}{\# \textit{Vertical Pixels}}$$



2017

BICSI Winter Conference & Exhibition

January 22-26 • Tampa, FL

Practical Example of ADM_{AF}

- A 75" 16:9 LCD monitor has an image height of 37"
- At 2160p (UltraHD), we can calculate the optimum viewing distance for full 4K appreciation as $(37 \times 3438) / 2160 = 5$ Feet
- At 1080p $(37 \times 3438) / 1080 = 9.9'$
- A 32" 4K computer monitor is at its best 25" from the screen!



2017

BICSI Winter Conference & Exhibition

January 22-26 • Tampa, FL

How Do We Handle Basic Decision Making?

“Decisions are made by people who have time, not people who have talent.” - Scott Adams

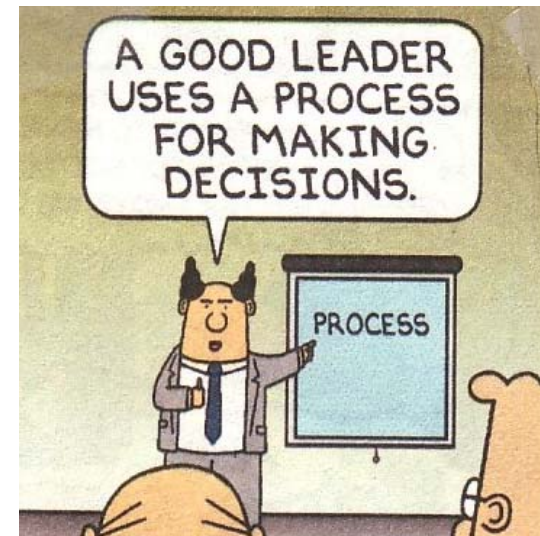

2017

BICSI Winter Conference & Exhibition

January 22-26 • Tampa, FL

Calculating The BDM_{AF}

- DISCAS Task Group used “Human Factors Ergonomics Society” standard, the 150-Rule, and acuity factor to facilitate objective guidance
 - For Basic Decision Making an Acuity factor of 200 was selected
- In BDM, viewer can make basic decisions that are not dependent on critical details within the image, but there is assimilation and retention of information.

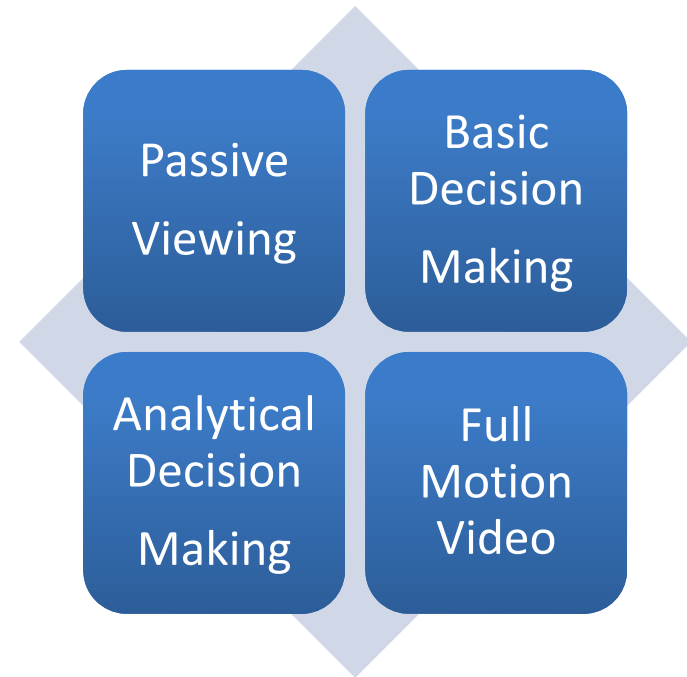

2017

BICSI Winter Conference & Exhibition

January 22-26 • Tampa, FL

What Is % Element?

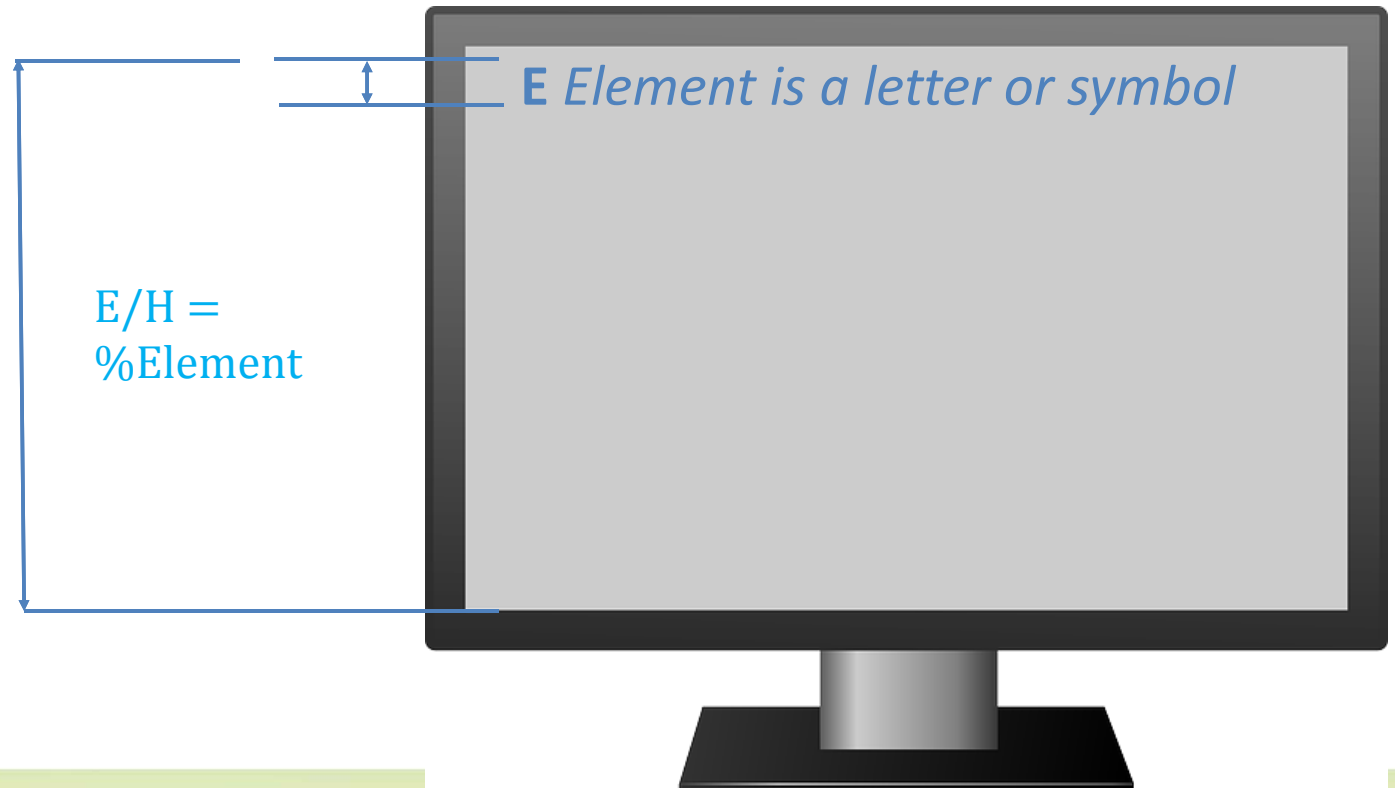

2017

BICSI Winter Conference & Exhibition

January 22-26 • Tampa, FL

An Example of 2.5% Element

30-2.5% There are many types, sizes, and complexity levels of audiovisual systems. The user should apply this standard as appropriate to fit the particular project circumstances. Two common approaches are described here, although there are many possible variations in contractual agreements and relationships between the design and construction team. For example: Consultant-led projects when the monetary value of the audiovisual systems is high, the building design and construction timeframe is long, or the installation work must be competitively bid. Independent consultants are persons or firms having neither financial interest in the products specified nor obligations or partnerships with equipment integrators, contractors, manufacturers, and their representatives. Design-build projects (also known as



2017

BICSI Winter Conference & Exhibition

January 22-26 • Tampa, FL

The Formula

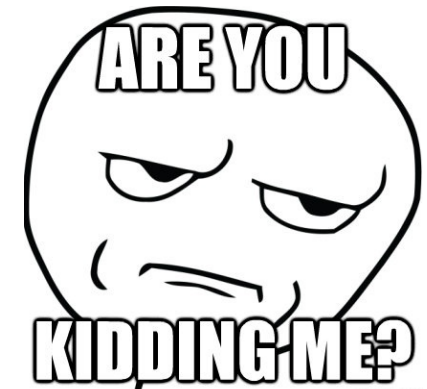

- $Image\ Height = \frac{Farthest\ Viewing\ Distance}{0.5 / \tan\left(\frac{MOA}{2}\right) * \%Element}$
- $Farthest\ Viewing\ Distance = Image\ Height * \frac{0.5}{\tan\left(\frac{MOA}{2}\right)} * \%Element$



2017

BICSI Winter Conference & Exhibition

January 22-26 • Tampa, FL

VISUAL ACUITY FOR NON-ANALYTICAL (BASIC) VIEWING

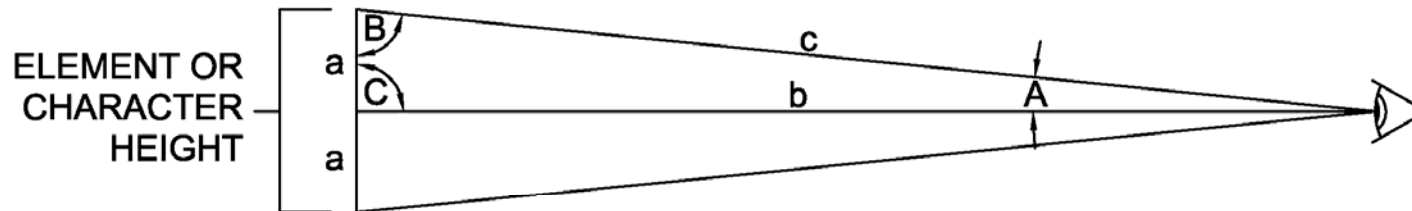

Element or Character Height = $2 \cdot a$
 Visual Acuity for Category = $2 \cdot A$
 Viewing Distance at Stated Acuity = b
 $\tan(A) = a/b$
 $b = a/\tan(A)$

ACUITY FACTOR FOR NON-ANALYTICAL (BASIC) VIEWING

$$\frac{0.5}{\tan(\text{Visual Acuity}/2)} = 200 \text{ for } 17.25 \text{ Minutes of Arc}$$



2017

BICSI Winter Conference & Exhibition

January 22-26 • Tampa, FL

Simplifying the Math...

- $Image\ Height = \frac{Farthest\ Viewing\ Distance}{200 * \%Element}$
- $Farthest\ Viewing\ Distance = Image\ Height * 200 * \%Element$
 - *Note: Outcome loosely reflects the earlier 4-6-8 RoT*
 - 2.0% @ 4, 3.0% @ 6, 4.0% @ 8



2017

BICSI Winter Conference & Exhibition

January 22-26 • Tampa, FL

A Practical Example For Basic Decision Making

- A 75" 16:9 LCD display has an image height of 37"
- Using 2.0%Element, we calculate the farthest acceptable viewer distance at 8.1 feet
- Using 3%Element, we calculate the farthest viewer at 12.2 feet



2017

BICSI Winter Conference & Exhibition

January 22-26 • Tampa, FL

Additional AV System Standards

ANSI/InfoComm 2M-2010 Standard Guide for
Audiovisual Systems Design and Coordination
Processes

ANSI/InfoComm 3M-2011 PISCAR

ANSI/InfoComm 3M-2011

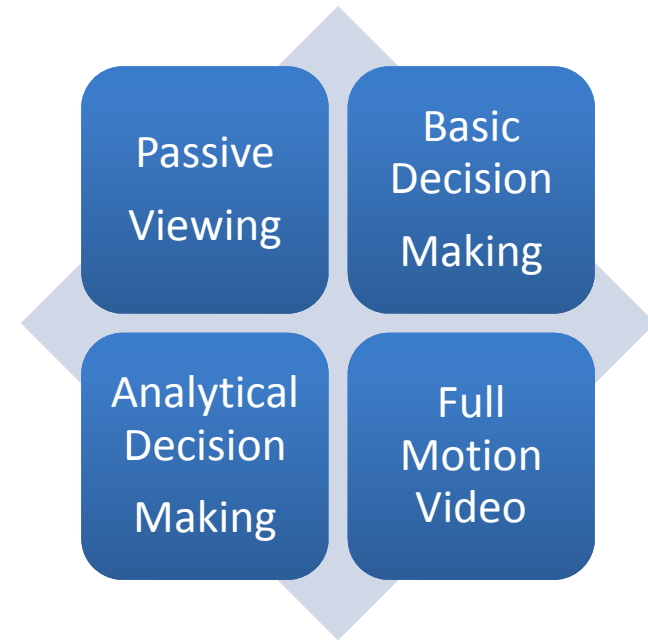

2017

BICSI Winter Conference & Exhibition

January 22-26 • Tampa, FL

**Break –
15 Minutes**



2017
BICSI Winter Conference & Exhibition
January 22-26 • Tampa, FL



How Do We Connect All This Stuff?

Bicsi

2017
BICSI Winter Conference
January 22-26 • Tampa, FL

Exhibition **YouTube**

Mobile Devices vs Fixed Infrastructure

"I have not failed. I have just found 10,000 ways that won't work."

— Nikola Tesla

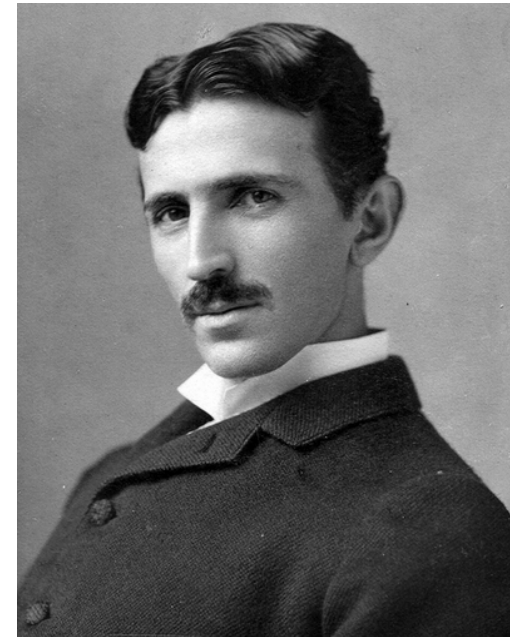

2017

BICSI Winter Conference & Exhibition

January 22-26 • Tampa, FL

Wireless Solutions Must Leverage Elements All Devices Have in Common

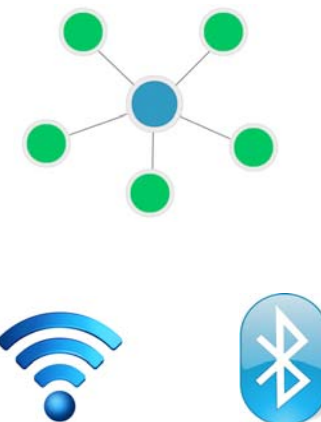
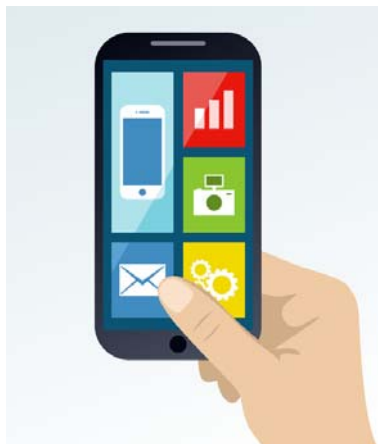

2017

BICSI Winter Conference & Exhibition

January 22-26 • Tampa, FL

Integrating Mobile Via The Lan

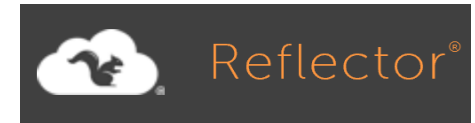
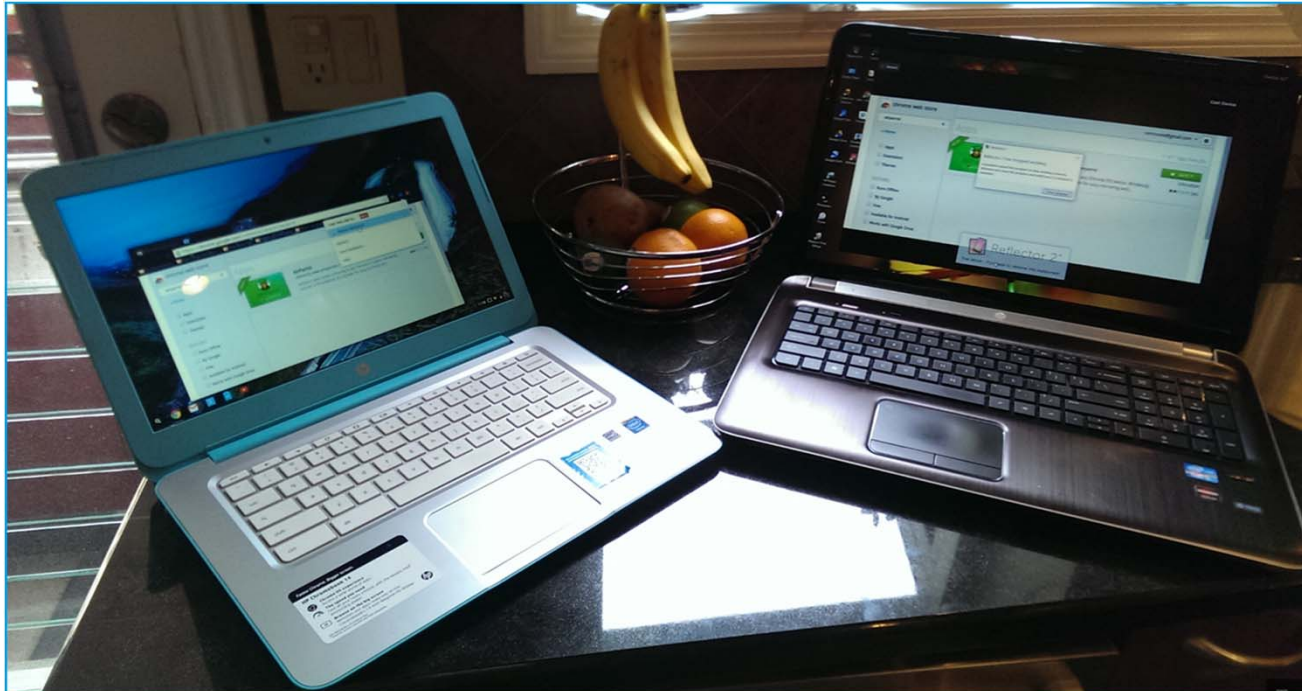

2017
BICSI Winter Conference & Exhibition
January 22-26 • Tampa, FL

AppleTV, Chromecast, FireTV, etc....

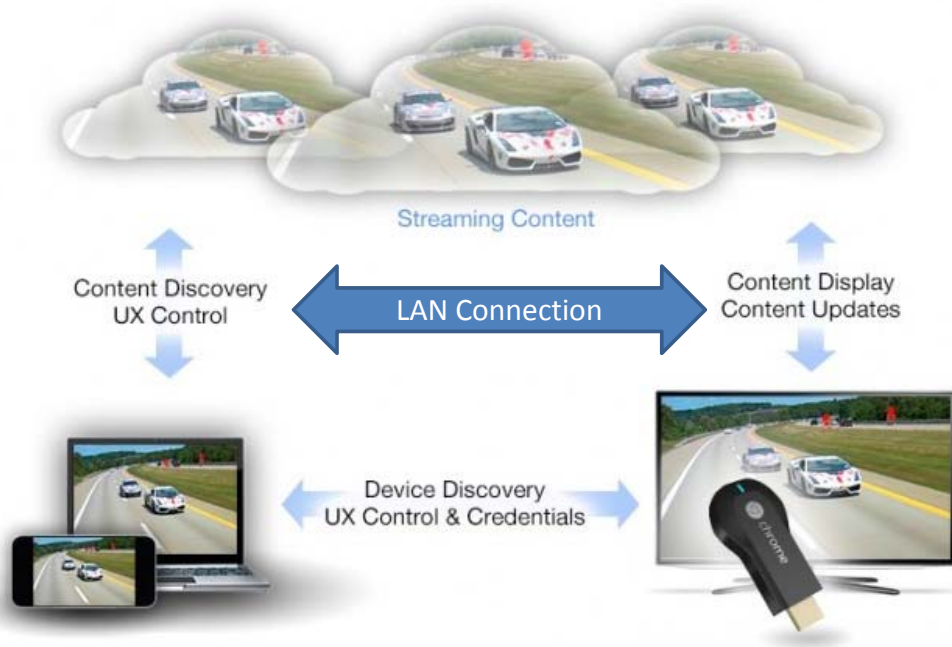

- **Apple TV** - macbooks, ipads and iPhone
- **Miracast** - android and recent windows systems, but not apple products
- **Allshare** - only Samsung galaxy phones and tablets
- **Chromecast** - macs, pcs, iOS and android devices – very limited true mirroring



2017

BICSI Winter Conference & Exhibition

January 22-26 • Tampa, FL

AirSquirrels.com



2017

BICSI Winter Conference & Exhibition

January 22-26 • Tampa, FL

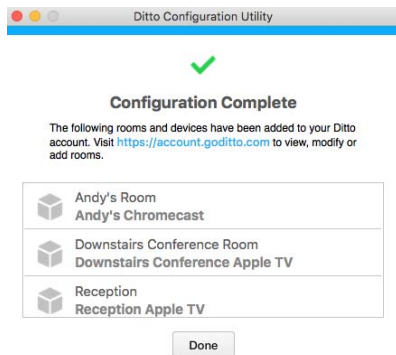
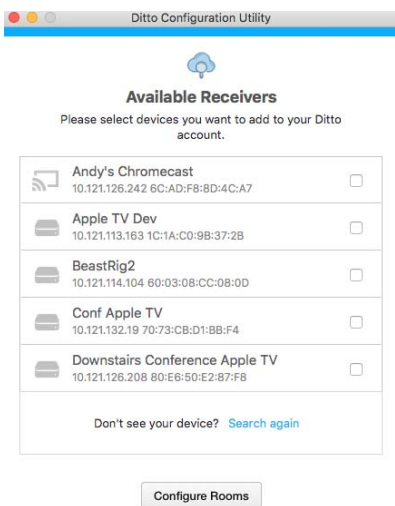
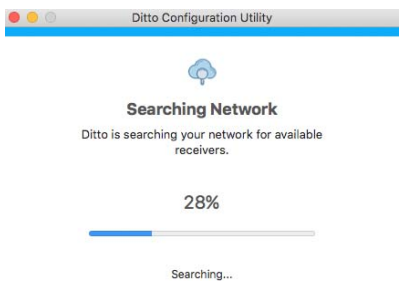

SHARE YOUR SCREEN
Ditto™
Visit <https://connect.goditto.com/> on your device

ENTER ROOM CODE
PATHETIC LIQUID



2017
BICSI Winter Conference & Exhibition
January 22-26 • Tampa, FL

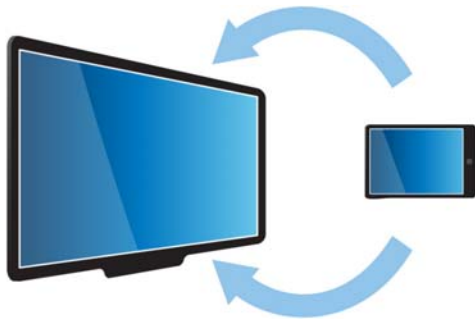

Wi-Fi Mirroring

How Can We Minimize Impact On The LAN?



Miracast

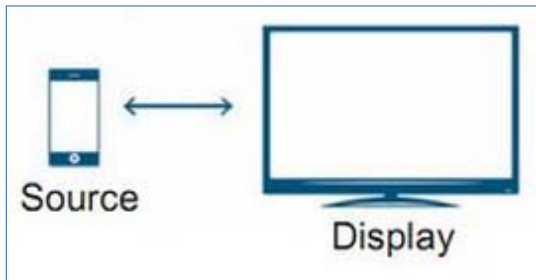

AirPlay

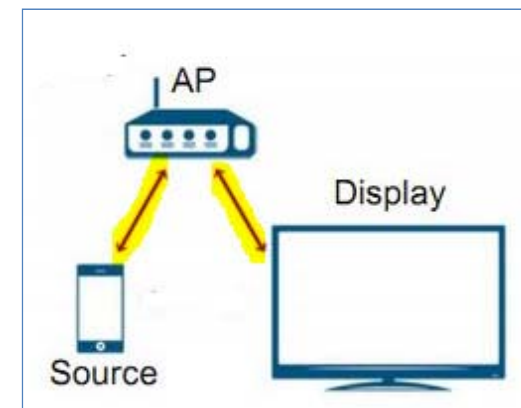

2017

BICSI Winter Conference & Exhibition

January 22-26 • Tampa, FL

The Power of Apps



- Wireless communication deployed via specialized Rx hardware and a set of “instructions” in the form of an active algorithm.
- Designed as a cross-platform, controllable bridge
- Operates with 802.11xx radio protocols
- Gate for the LAN
- Creates both WAP & WiDi channels



2017
BICSI Winter Conference & Exhibition
January 22-26 • Tampa, FL

Why Not Bluetooth?

- Bluetooth is designed for low bandwidth applications where higher USB transfer speeds are not required, and a cable-free connection is desired.
- Bandwidth limited to 721Kbps
- Both connection range and data rates make useful, dependable video connections impractical.



2017

BICSI Winter Conference & Exhibition

January 22-26 • Tampa, FL

Industry Impact Of USB Technology

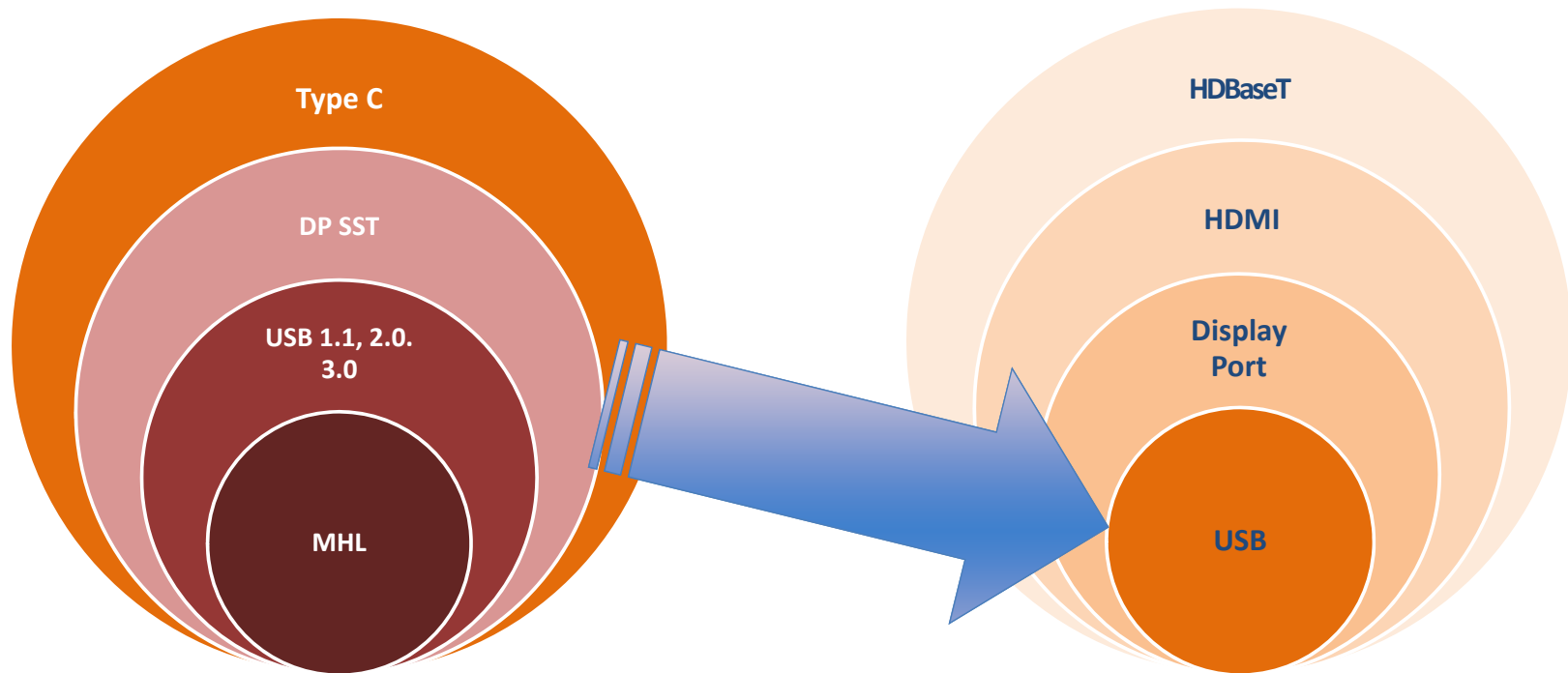

2017

BICSI Winter Conference & Exhibition

January 22-26 • Tampa, FL

Universal Serial Bus

- Every mobile device leverages USB
- Every interactive panel demands USB
- Every computer supports USB

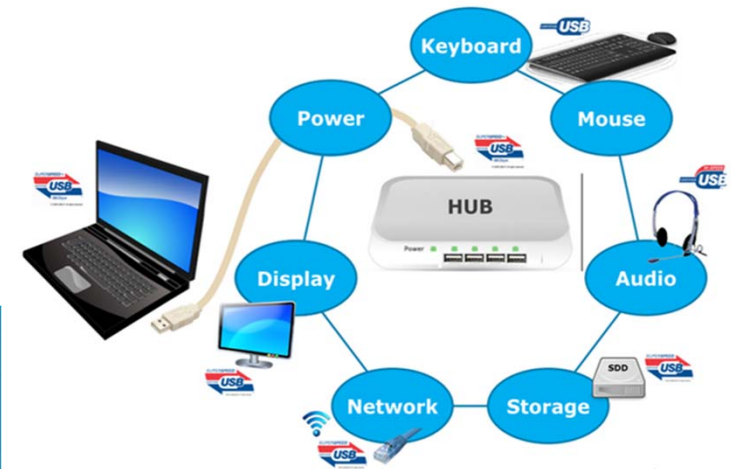

2017

BICSI Winter Conference & Exhibition

January 22-26 • Tampa, FL

Apple, Google, Microsoft...



2017

BICSI Winter Conference & Exhibition

January 22-26 • Tampa, FL

So What Is Type-C?



2017

BICSI Winter Conference & Exhibition

January 22-26 • Tampa, FL

High Speed Data Path (TX for USB, or for DP Alt Mode)

USB 2.0 Interface

High Speed Data Path (RX for USB, or TX for DP Alt Mode)

A1	A2	A3	A4	A5	A6	A7	A8	A9	A10	A11	A12
GND	TX1+	TX1-	VBUS	CC1	D+	D-	SBU1	VBUS	RX2-	RX2+	GND
GND	RX1+	RX1-	VBUS	SBU2	D-	D+	CC2	VBUS	TX2-	TX2+	GND
B12	B11	B10	B9	B8	B7	B6	B5	B4	B3	B2	B1

Cable Ground

Cable Bus Power

For Sideband Use (not used for USB)

Plug Configuration Detection

- One becomes V_{CONN} , for cable or adaptor power
- CC is used for USB-PD communication



2017
BICSI Winter Conference & Exhibition
 January 22-26 • Tampa, FL

Alternate Mode

USB Host or Device with DisplayPort Alternate Mode Capability.

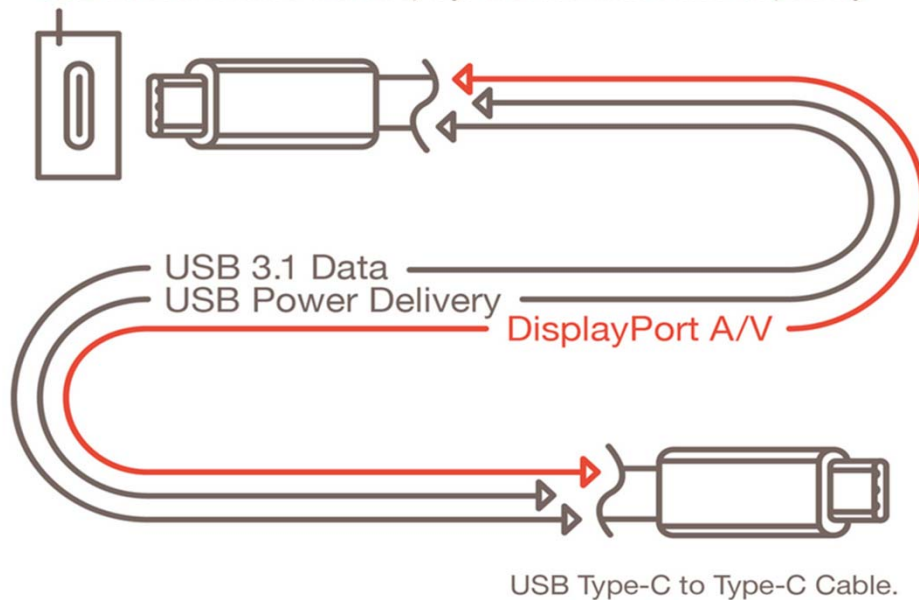

- 2 Bi-directional data lanes (total of four lanes) in the USB Type-C link allow for simultaneous flow of non-USB payloads
 - ✓ Facilitates flow of display data without interrupting USB data
 - ✓ DP1.2a SST supports up to 4096 x 2160 @ 60Hz with RGB 10-bit color space
- DisplayPort is the connection of choice for laptop and desktop productivity technology



2017

BICSI Winter Conference & Exhibition

January 22-26 • Tampa, FL

Digital Visual Interface - DVI

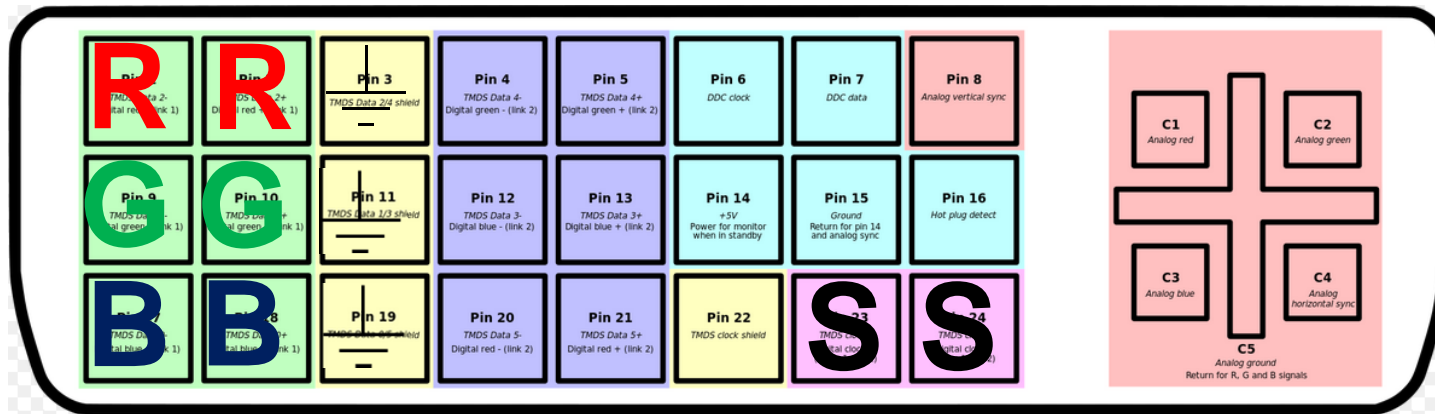

2017

BICSI Winter Conference & Exhibition

January 22-26 • Tampa, FL

HDMI Pin-Out

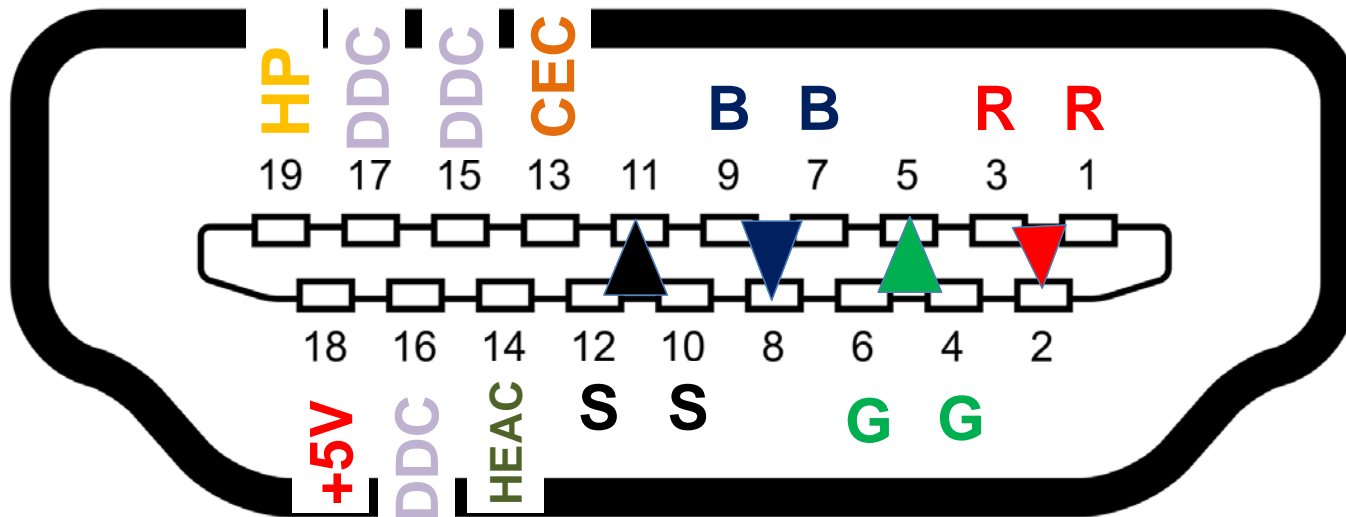

2017

BICSI Winter Conference & Exhibition

January 22-26 • Tampa, FL

High Definition Multi-Media Interface

- HDMI remains the standard for accessing AV content from multimedia devices
- HDMI industry growth is projected to be more than 9% CAGR
- Installed base will grow to eight billion units worldwide by 2018!

HDMI
HIGH-DEFINITION MULTIMEDIA INTERFACE
2.0



2017

BICSI Winter Conference & Exhibition

January 22-26 • Tampa, FL

Highlights of HDMI 2.0

- HDMI 1.4 describes most current product, including 4:2:0 4096x2160p24 and 3840x2160p30 (UltraHD, UHD)
 - HDBT does not support HDMI HEAC
- HDMI 2.0 “supports” 4:4:4 2160p60
 - Bandwidth increased from 10.2Gbps to 18Gbps
 - Supports single display MST
 - Improved CEC extensions
- HDMI 2.0 is not a “firmware” upgrade for almost all relevant products

	8bit	10bit	12bit	16bit
4K@24				
4K@25	RGB 4:4:4	RGB 4:4:4	RGB 4:4:4 4:2:2	RGB 4:4:4
4K@30				
4K@50	RGB 4:4:4	4:2:0	4:2:2 4:2:0	4:2:0
4K@60	4:2:0			



2017

BICSI Winter Conference & Exhibition

January 22-26 • Tampa, FL

DisplayPort Connector Map

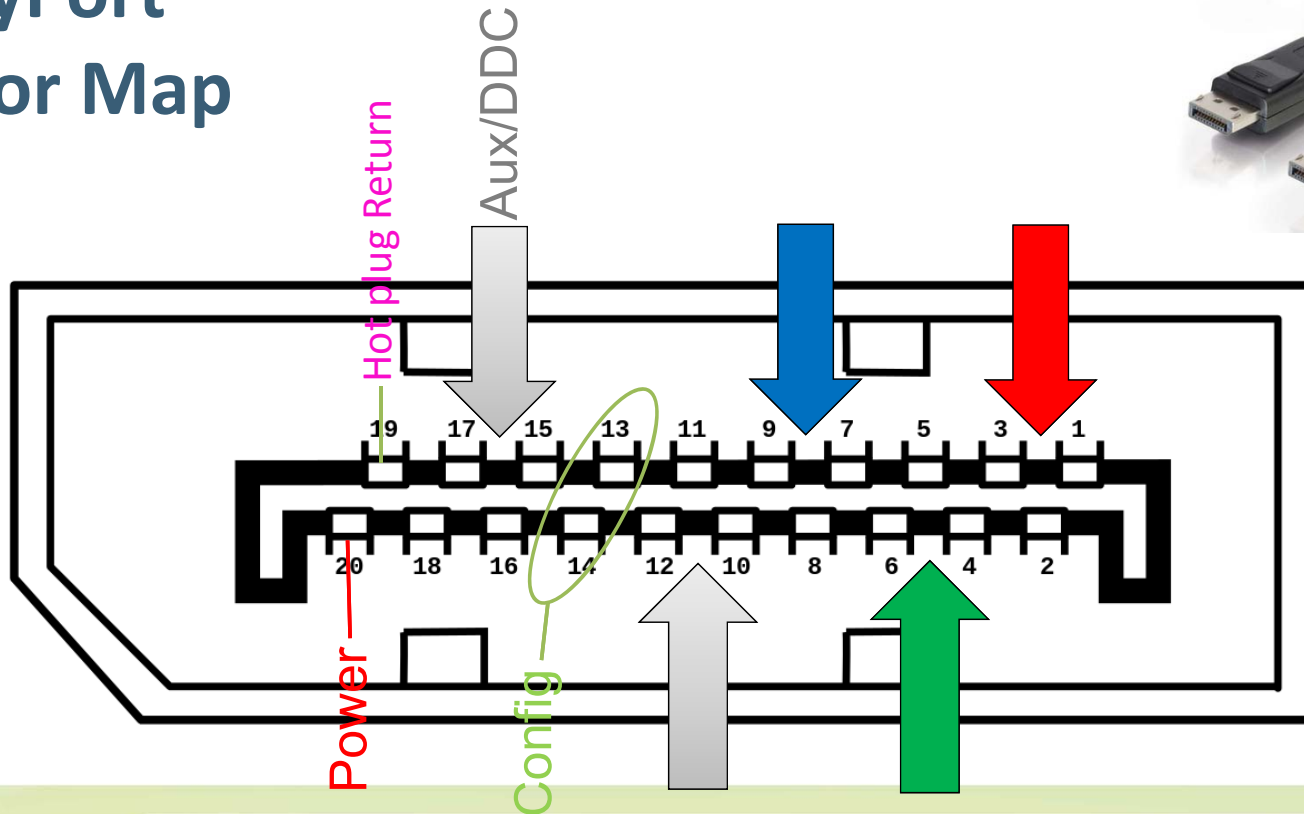

2017

BICSI Winter Conference & Exhibition

January 22-26 • Tampa, FL

DisplayPort and DP++

- Native MST for extended desktop and multi-display installations
- Up to 8.1 Gbit/s per lane
 - Dual lane allocation supports UltraHD 2160p resolutions
- Supports RGB and YCbCr Color Space
 - W/ up to 8-channels embedded audio
- ***DisplayPort 1.1, not DP++, is embedded in USB Type-C***

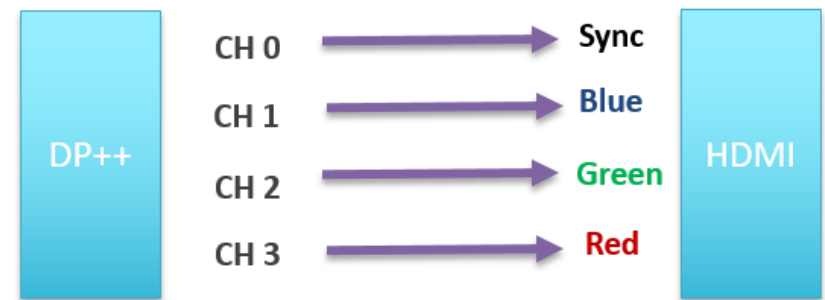

2017

BICSI Winter Conference & Exhibition

January 22-26 • Tampa, FL

HDBaseT

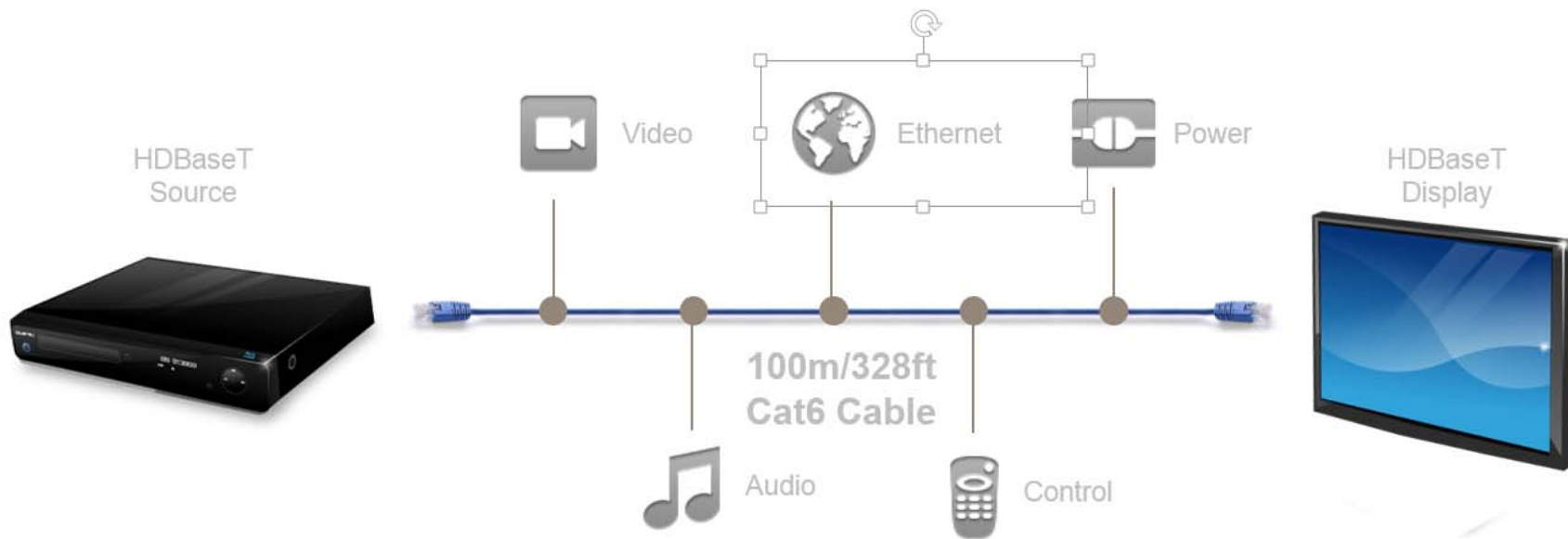

2017

BICSI Winter Conference & Exhibition

January 22-26 • Tampa, FL

HDBaseT™ Supports Daisy Chain Architecture

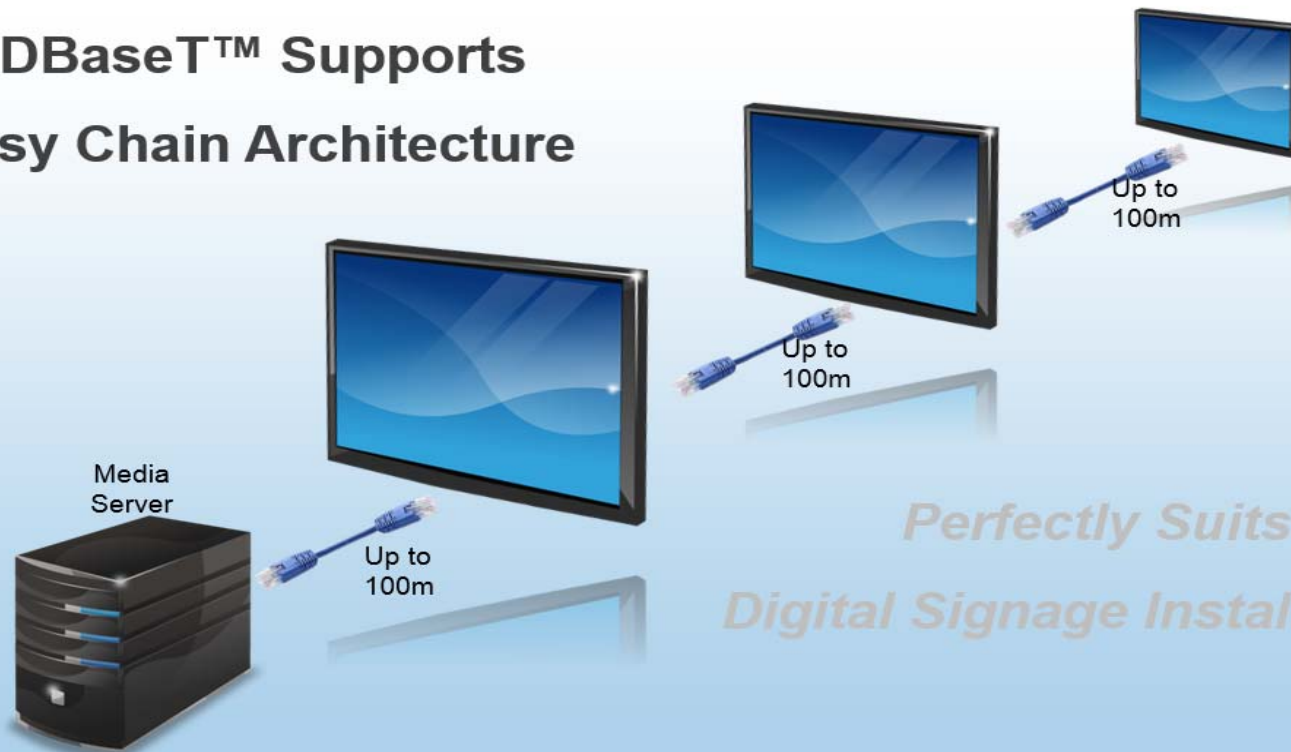

*Perfectly Suits
Digital Signage Installations*



2017

BICSI Winter Conference & Exhibition

January 22-26 • Tampa, FL

The Open Source 7-Layer Model

- In the seven-layer OSI model of computer networking, the physical layer or layer 1 is the first and lowest layer.
- The implementation of this layer is often termed PHY.
- The physical layer consists of the basic networking hardware transmission technologies of a network.
- It is a fundamental layer underlying the logical data structures of the higher level functions in a network.

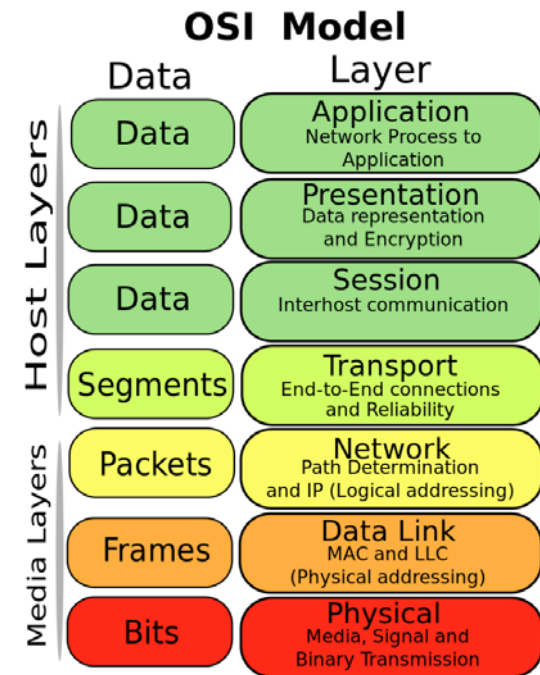

2017

BICSI Winter Conference & Exhibition

January 22-26 • Tampa, FL

Gigabit Ethernet Uses PAM-5

- 1000Base-T uses PAM5 encoding, where each transmitted symbol represents one of five levels: -2 , -1 , 0 , $+1$, $+2$
 - Four levels represent two bits; the fifth level supports forward error correction (FEC)
 - As the number of levels increases, susceptibility to noise increases proportionately
- Broadcast digital television (ATSC) 8VSB uses Pam-3, 32Mbit/s over 6MHz channel
- 10GBase-T, 25GBase-T and 50GBase-T use a far more demanding PAM-16 scheme

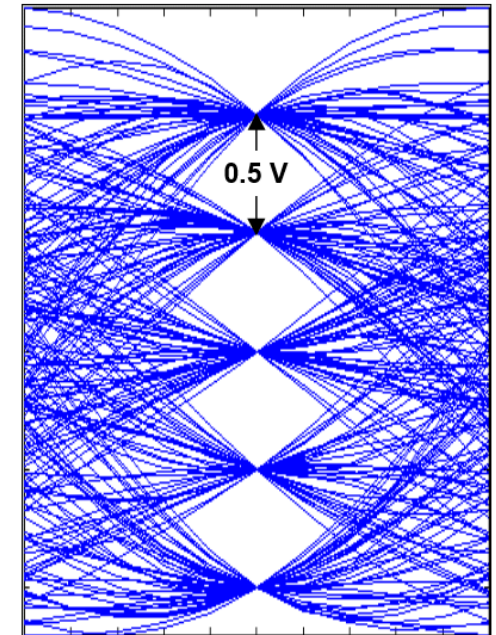

2017

BICSI Winter Conference & Exhibition

January 22-26 • Tampa, FL

Everything Comes At A Cost

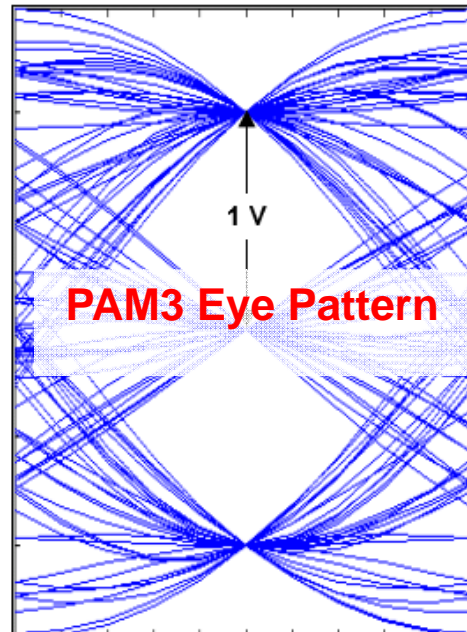
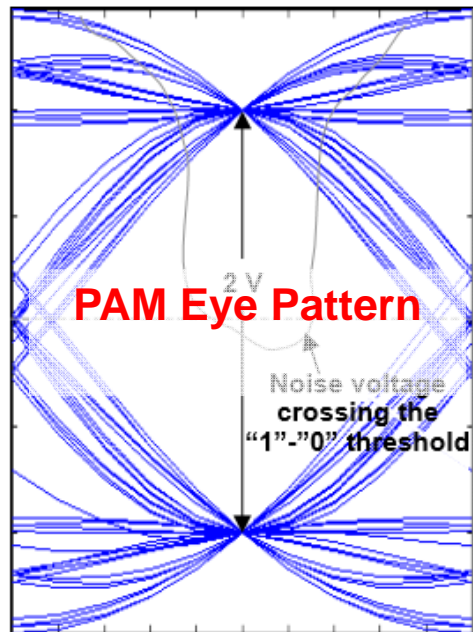

$$20 \text{ Log } (1\text{V}/2\text{V}) = 6 \text{ dB degradation}$$

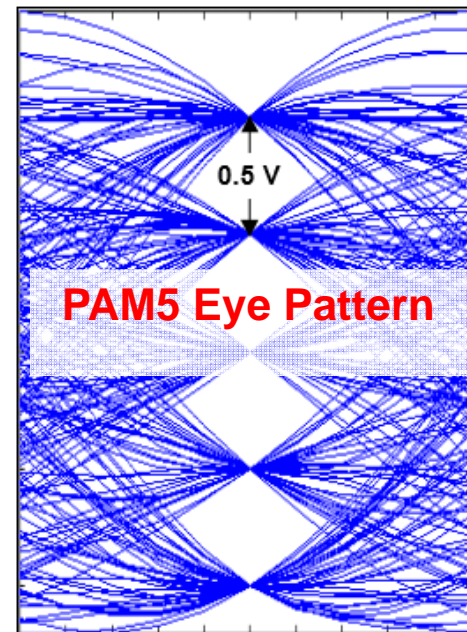

$$20 \text{ Log } (0.5\text{V}/2\text{V}) = 12 \text{ dB degradation}$$



2017

BICSI Winter Conference & Exhibition

January 22-26 • Tampa, FL

Pulse Amplitude Modulation 16

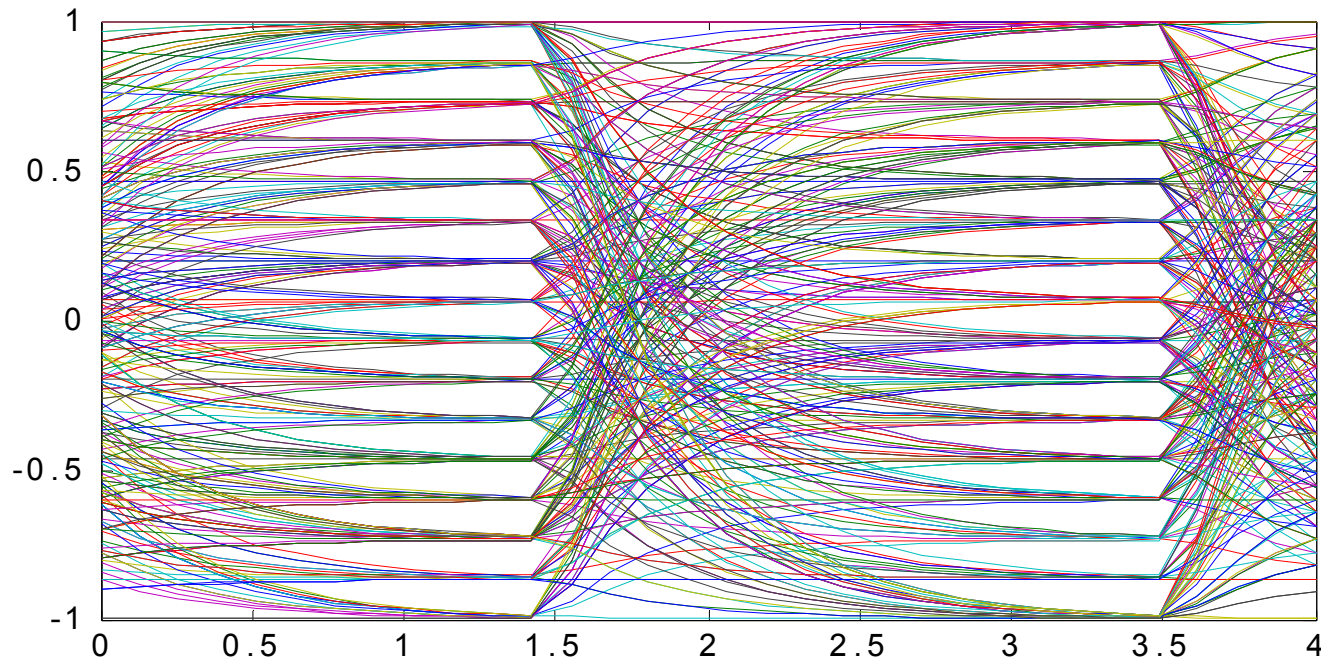

HDBaseT uses PAM16 symbols where each symbol is transmitted using one of 16 discrete, differential voltage levels, each representing 4 bits of data



2017

BICSI Winter Conference & Exhibition

January 22-26 • Tampa, FL

Physical Layer Considerations

- Near End Crosstalk (NEXT)
 - EMI Crosstalk from one pair to another pair
 - Expressed in dB/ft or dB/1000ft
- Far End Crosstalk (FEXT)
 - Interference between two pairs measured at the far end with respect to the interfering transmitter
- Alien Crosstalk (AXT)
 - Interference caused by other cables routed close to the cable of interest

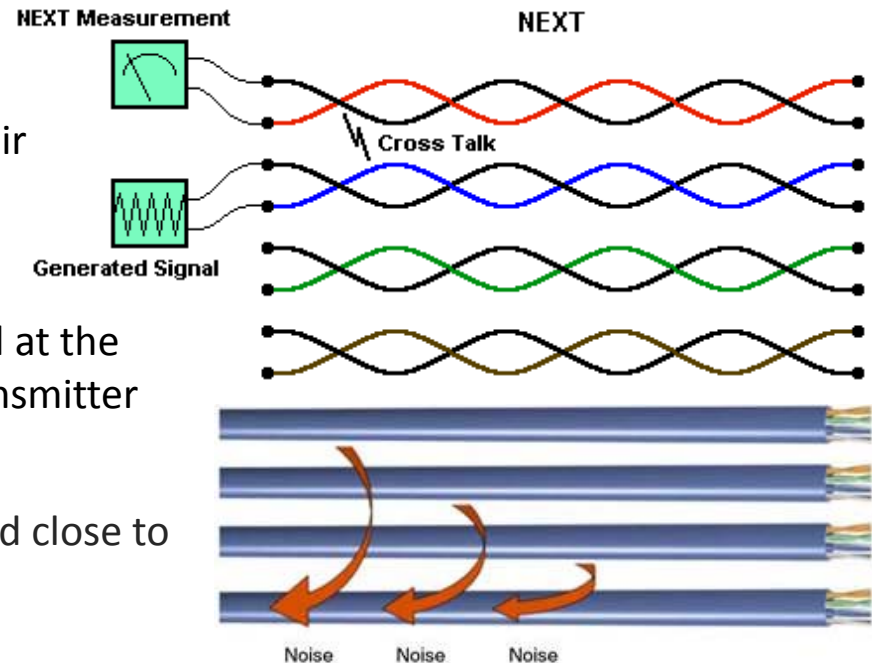

2017

BICSI Winter Conference & Exhibition

January 22-26 • Tampa, FL

Example of Cat6 F/UTP

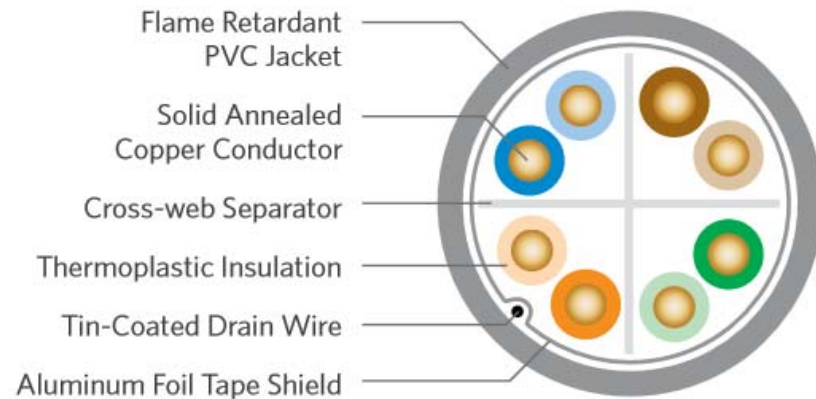

SPECIFICATIONS

Configuration	Copper pairs surrounded by aluminum PET foil with an outer drain wire and jacket
Pair Count	4
Conductor	Solid annealed copper
AWG (mm)	23 (0.57)
Insulation	CMR: Thermoplastic CMP: FEP
Insulation Colors	Pair 1: ColorTip Light Blue, Blue Pair 2: ColorTip Light Orange, Orange Pair 3: ColorTip Light Green, Green Pair 4: ColorTip Light Brown, Brown
Separator	Cross-web
Shield	Aluminum/PET with 10% overlap
Drain Wire	Tinned copper
Jacket	CMR: Flame retardant (FR) PVC CMP: FR, low smoke PVC
Characteristic Impedance Ohms	100 ± 15
Nominal Velocity of Propagation %	CMR: 66 CMP: 71

Example – HDBaseT Certified
Superior Essex 6T-246-3A



2017

BICSI Winter Conference & Exhibition

January 22-26 • Tampa, FL

Non-Continuous Shielding

Segmented shield can provide protection similar to continuous shield

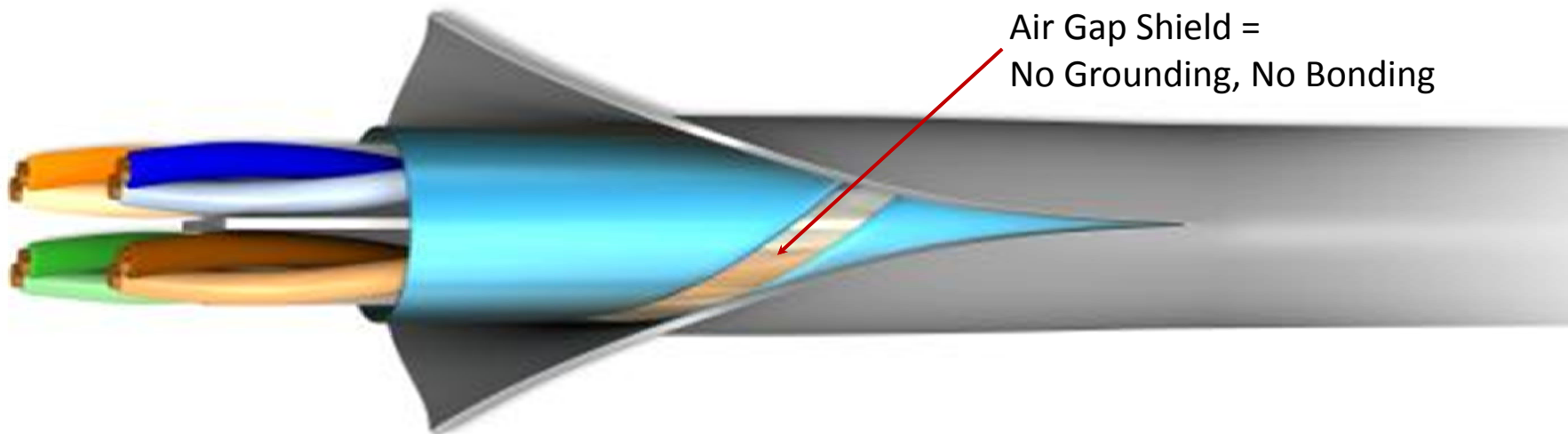

Example – HDBaseT Certified Superior Essex Category 10Gain® XP CAT 6A U/UTP



2017

BICSI Winter Conference & Exhibition

January 22-26 • Tampa, FL

Power Over HDBaseT - PoH

- PoH is based on the IEEE 802.3at-2009 POE+
- 50- to 57-volt DC over four pairs
 - 1000mA per two-pairs
- Instead of the powered device assuming worst-case cabling, POH allows the device itself to identify the cable length and draw more power as long as it does not exceed 100W
- Backwards compatible with section 33.7.1 mandate to conform to IEC 60950-1:2001
- Classified as a Limited Power Source (LPS), compliant with all PoE safety requirements

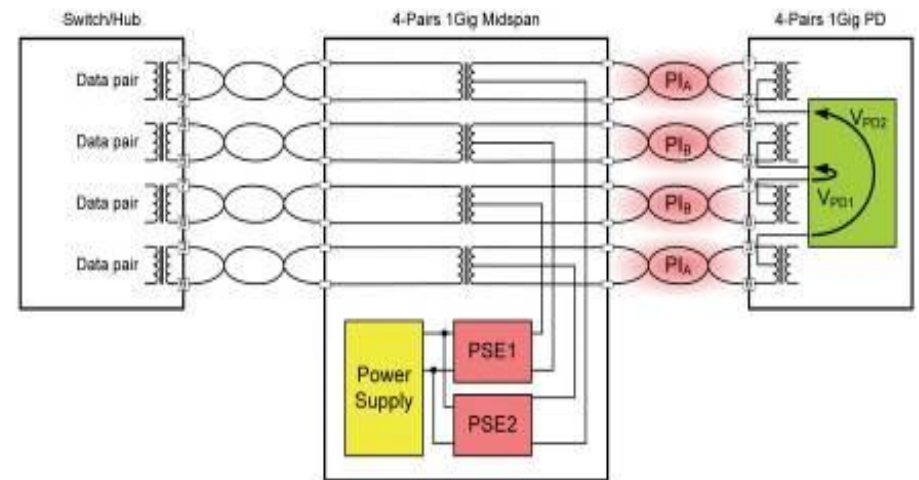

2017

BICSI Winter Conference & Exhibition

January 22-26 • Tampa, FL

PoH Midspan

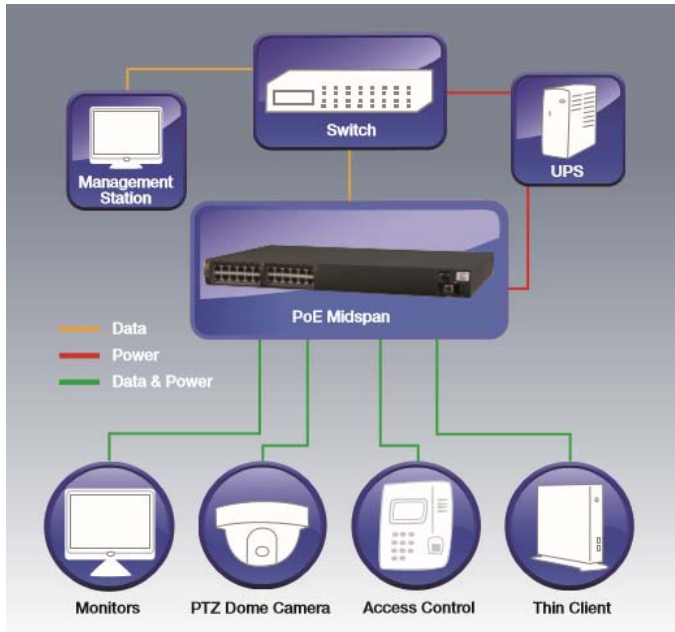

- PoH supports midspan options
 - HDBaseT Alliance chose Microsemi 4-pair detection methodology to insert power
- DC Ω imbalance can distort payload

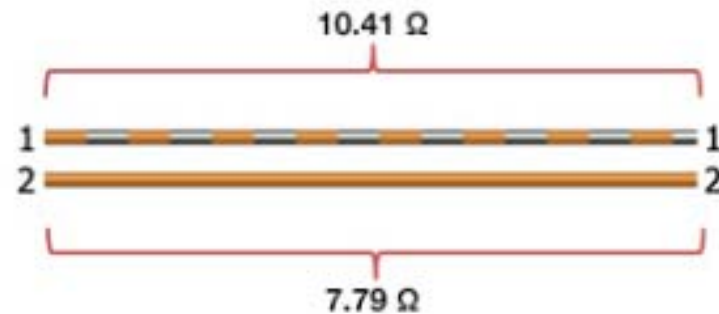

DC Loop Resistance = 18.2Ω
DC Resistance Unbalance = 2.62Ω



2017
BICSI Winter Conference & Exhibition
January 22-26 • Tampa, FL

HDBaseT Lite

- Operational advantages of HDBaseT at a lower price
 - 60 meter maximum
 - Supports UltraHD 2160p in 4:2:0



2017

BICSI Winter Conference & Exhibition

January 22-26 • Tampa, FL

HDBaseO

- 2nd Generation VS2311 - 5Play™
Gen 2.0 Fiber - HDBaseT over fiber for transmission over much longer distances
 - Can be used for single mode (SMF) and multi-mode (MMF) solutions
 - Supports MST and HDBT2.0 performance
 - 600m with OM3 MM fiber / 800m with OM4 MM fiber / 1Km / 10 Km - standard HDBaseT 2.0 over fiber optics

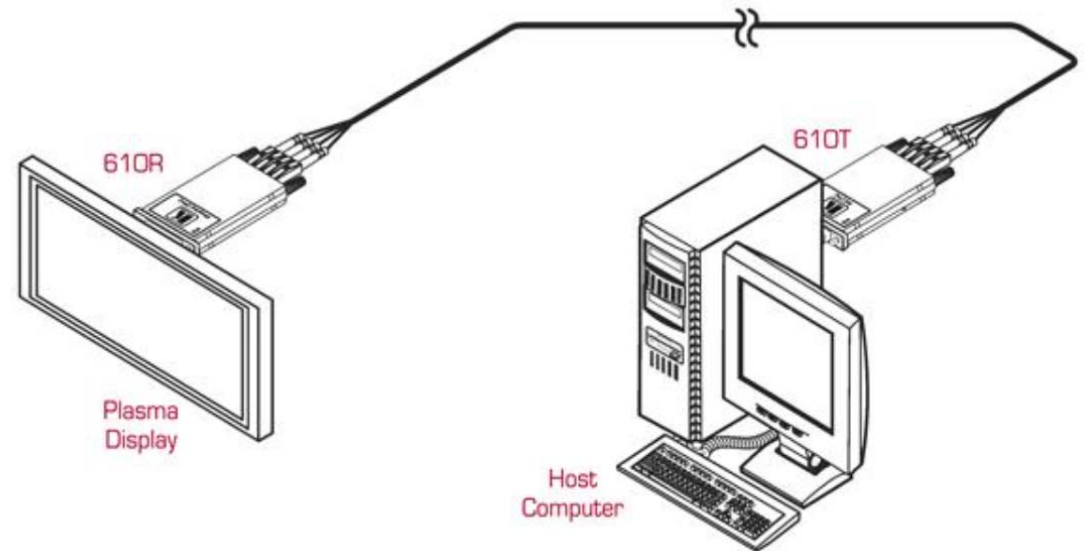

2017

BICSI Winter Conference & Exhibition

January 22-26 • Tampa, FL

Where A/V-over-IP Lives

- Streaming media
- Downloadable files
- Social media
 - Understand JPEG2000, H.264, H.265, HTML 5, WEB RTC, etc.
 - Lecture capture *is* an element of teleconferencing/telepresence
 - Consider synchronous versus asynchronous communication needs

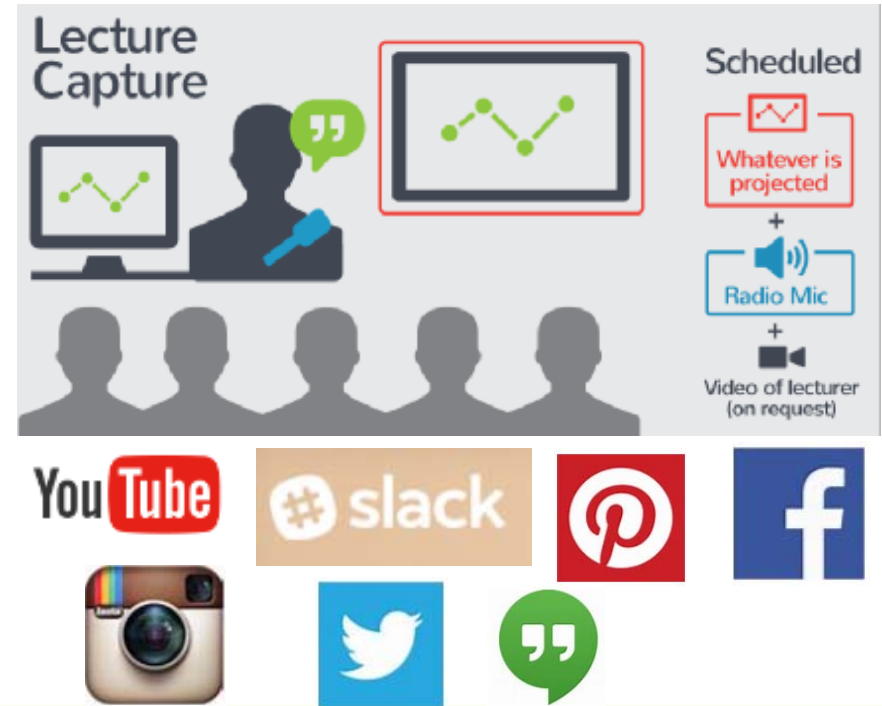

2017

BICSI Winter Conference & Exhibition

January 22-26 • Tampa, FL

The Conclusion Is The Place Where You Get Tired Of Thinking.

*“The best ideas come as jokes.
Make your thinking as funny as
possible.” - David M. Ogilvy*



2017

BICSI Winter Conference & Exhibition

January 22-26 • Tampa, FL

- “Convergence” doesn’t mean everything will be delivered over the network!
- Digital Natives and Analog Migrants will place unexpected demands on technology deployment
- 4K video content and BYOD pressures are driving a revolution on connectivity design
- The best solutions for education include both wired and wireless technologies, each optimized for a specific result
- Learning is not the same as learning to learn. Practical issues in society today will place a premium on the student’s ability to find, assimilate and apply information.



2017

BICSI Winter Conference & Exhibition

January 22-26 • Tampa, FL

A Final Thought To Take With You

*"If it works, it's obsolete" –
Marshall McLuhan*

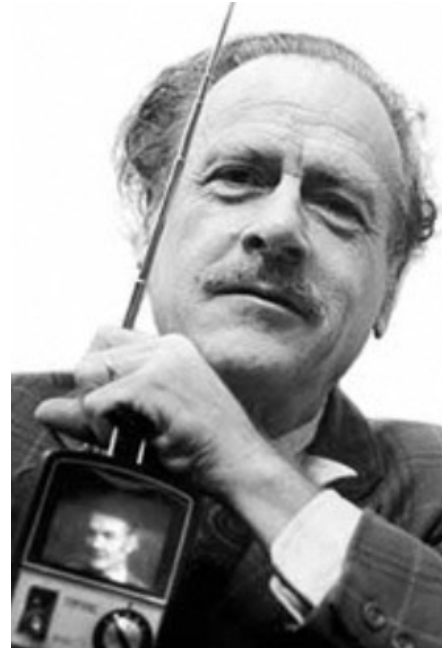

2017

BICSI Winter Conference & Exhibition

January 22-26 • Tampa, FL

Are there any questions about where we've been, or where we're going?

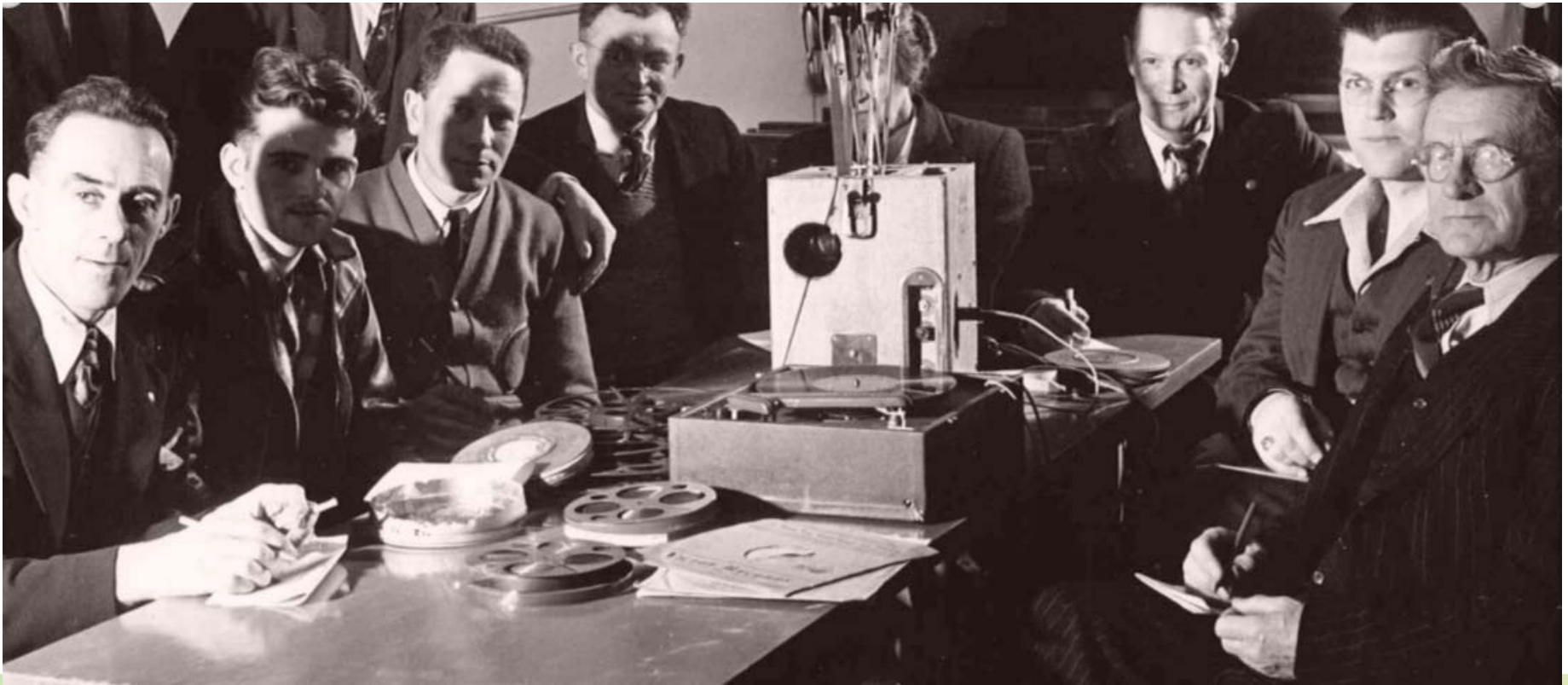

2017

BICSI Winter Conference & Exhibition

January 22-26 • Tampa, FL



2017

BICSI Winter Conference & Exhibition

January 22-26 • Tampa, FL